

COMPOSIZIONE REPLAY160

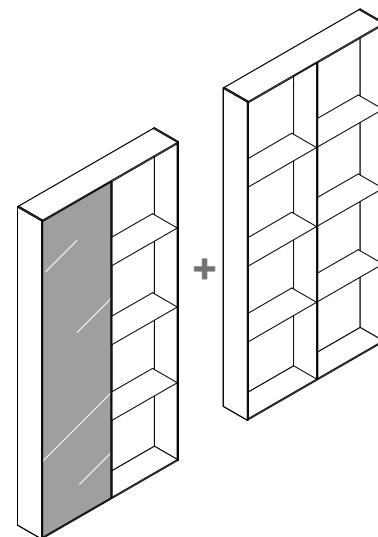

COMPOSIZIONE REPLAY160

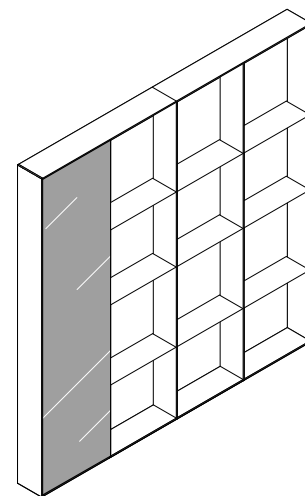
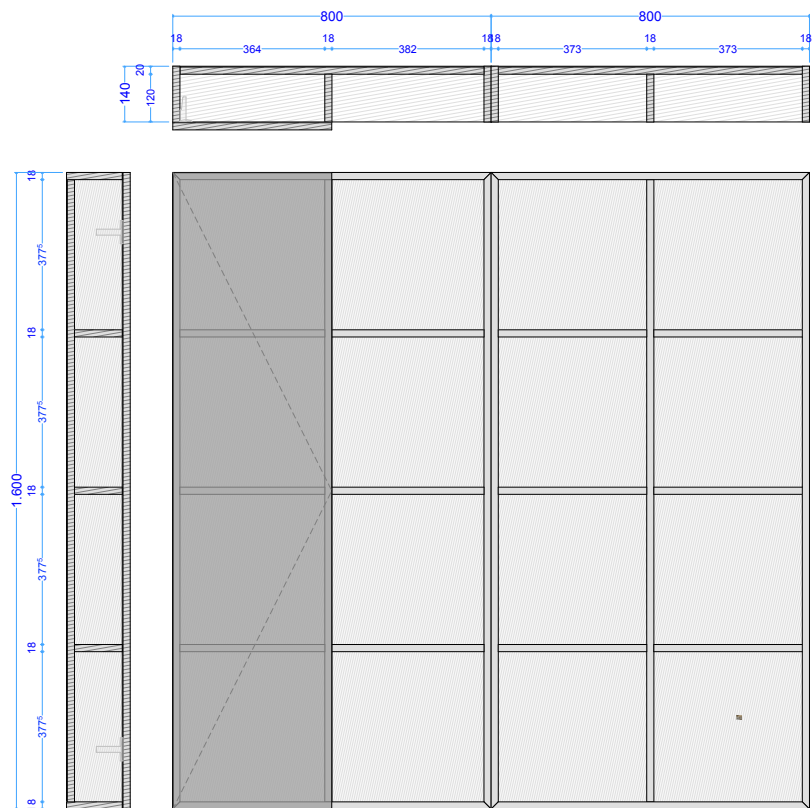
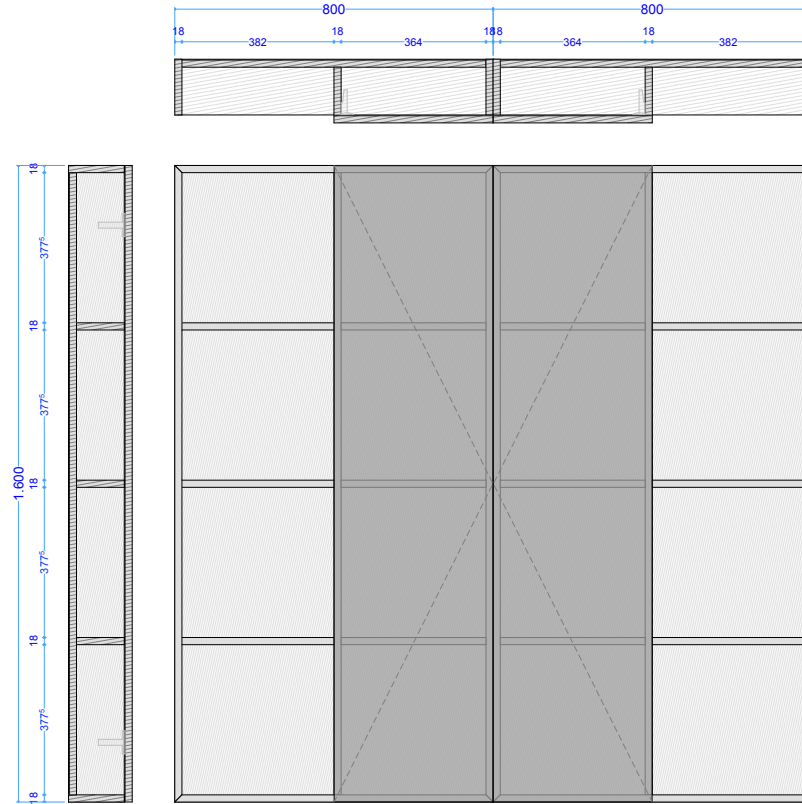

R6GI080160_

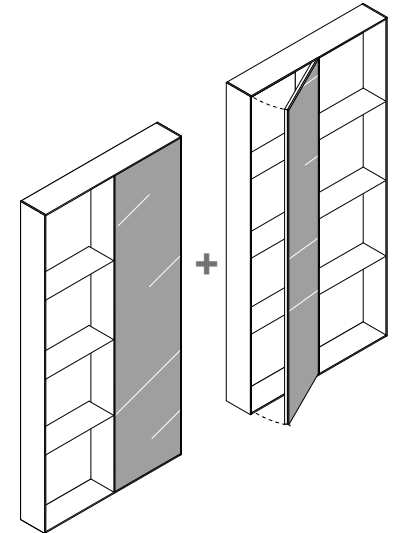
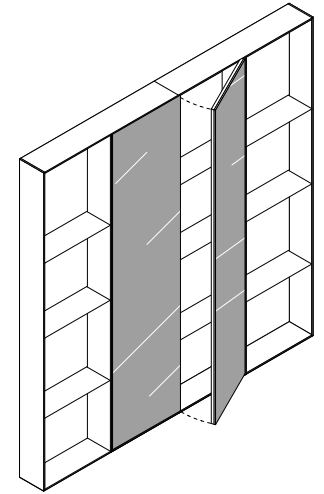

REPLAY - pensile 40 verticale a giorno

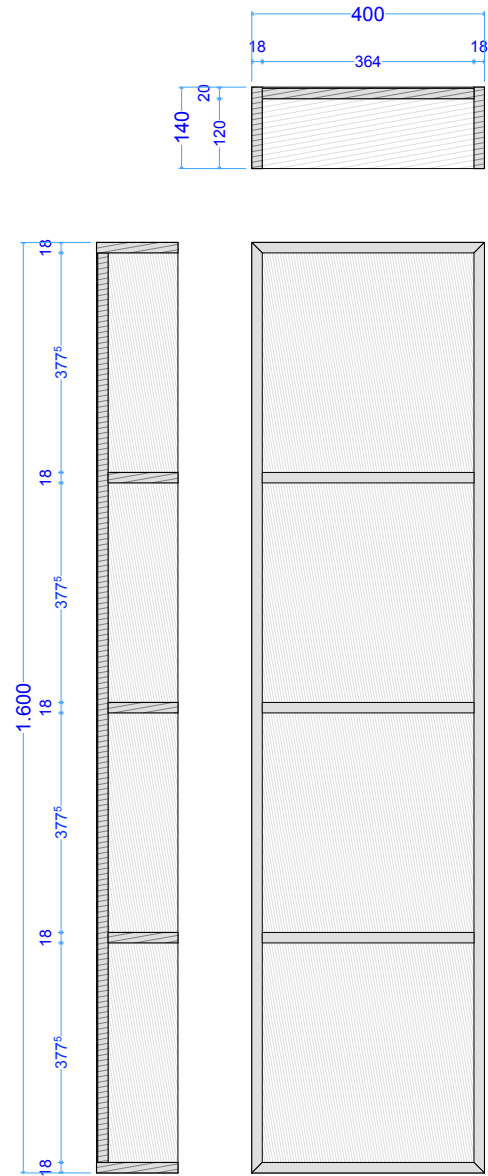

R6GI040160_

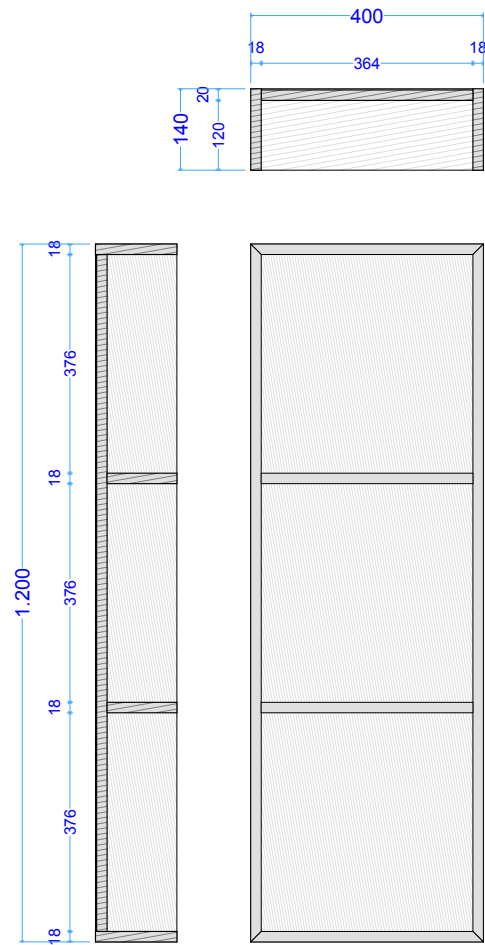

R6GI040120_

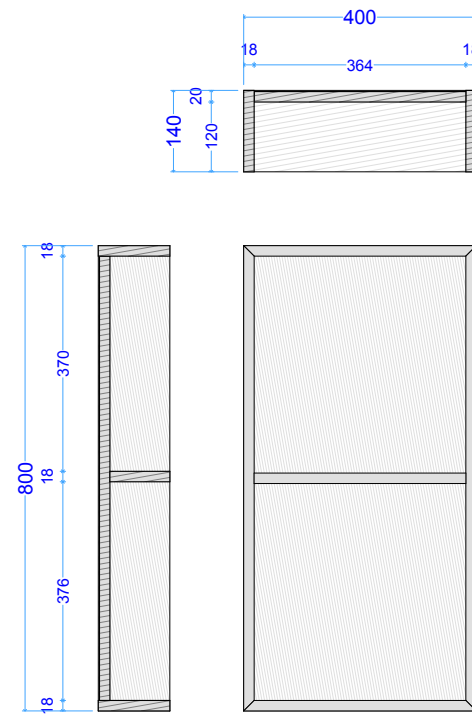

R6GI040080_

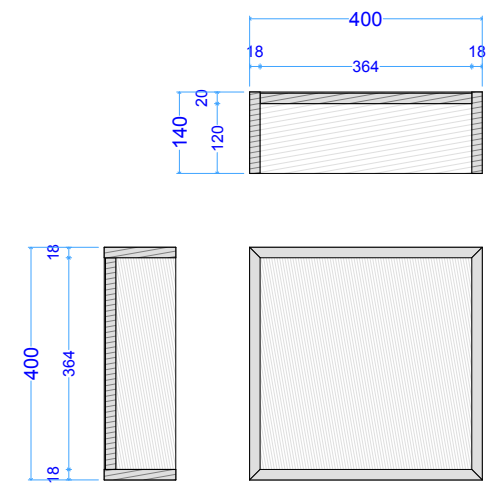

R6GI040040_

REPLAY - pensile 40 verticale a notte

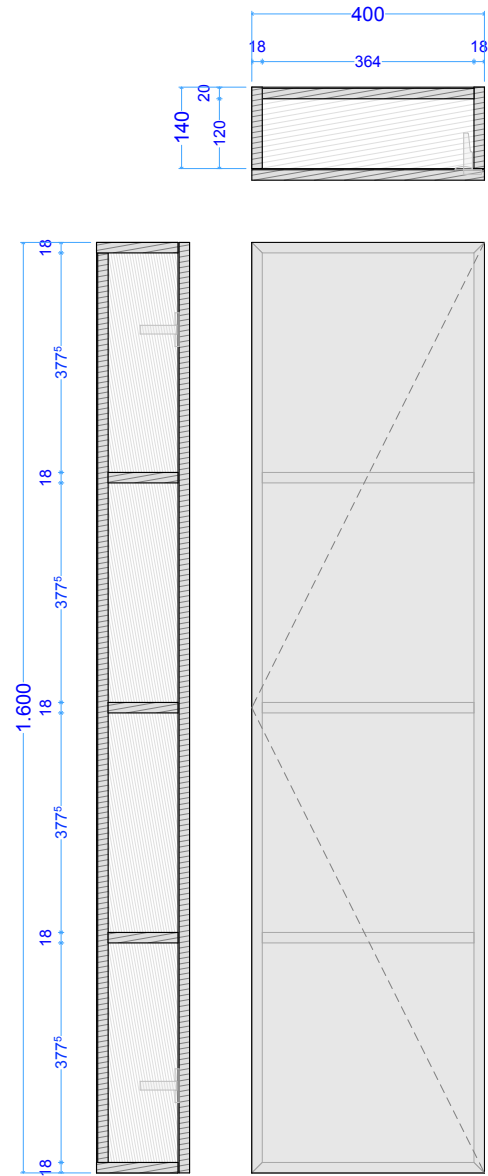

R6A_040160__

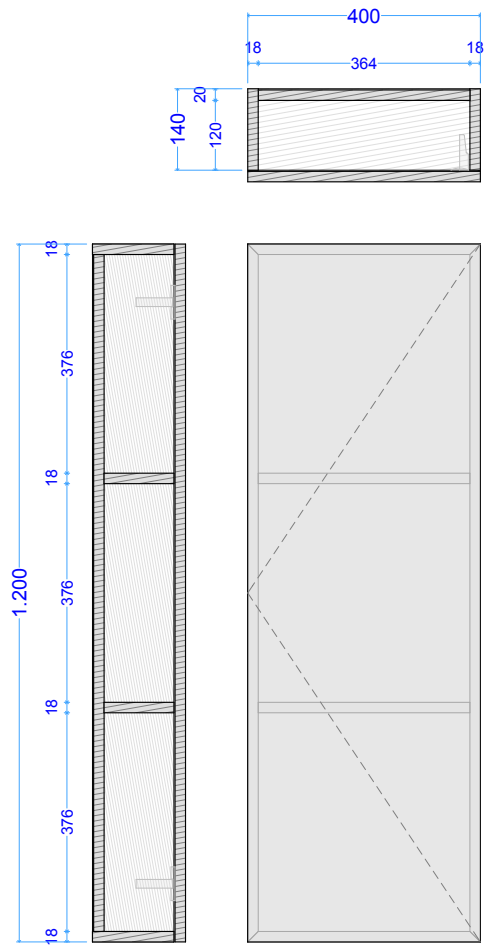

R6A_040120__

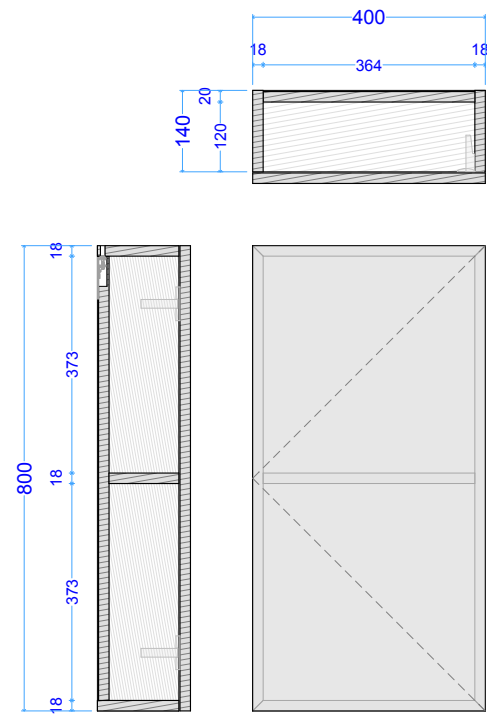

R6A_040080__

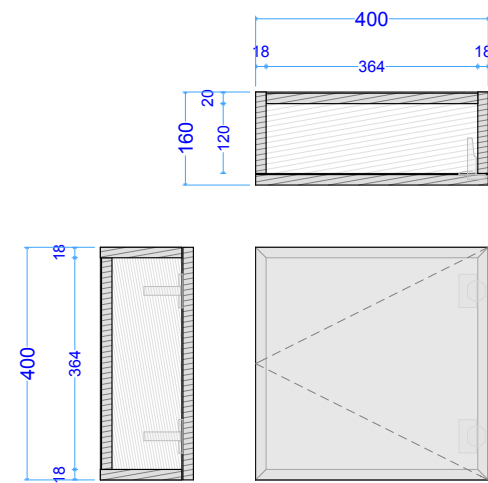

R6A_040040__

REPLAY - pensile 80 verticale a giorno

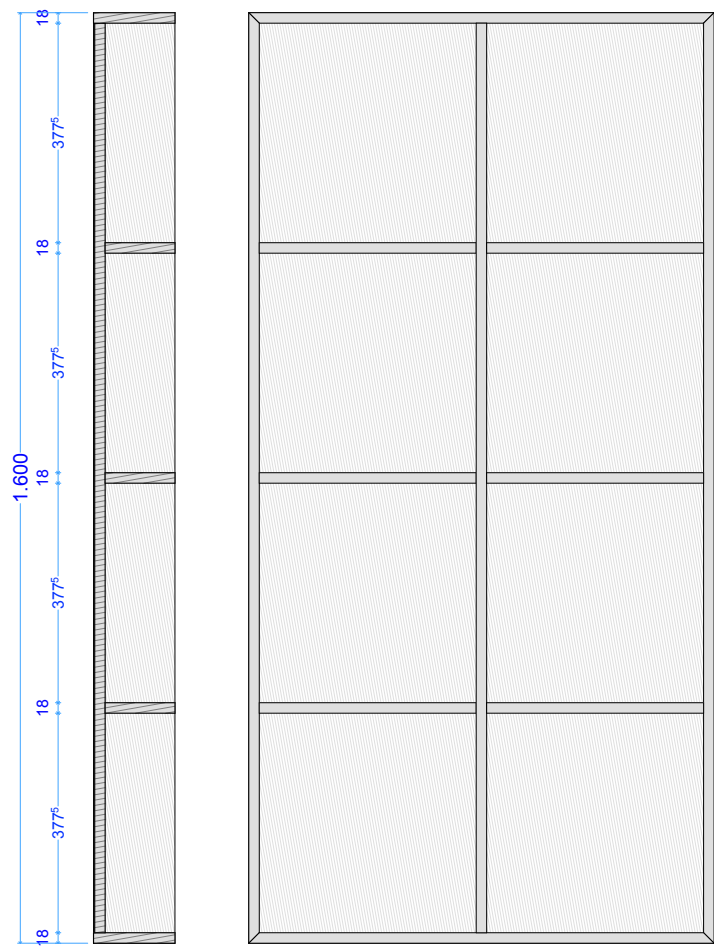

R6GI080160__

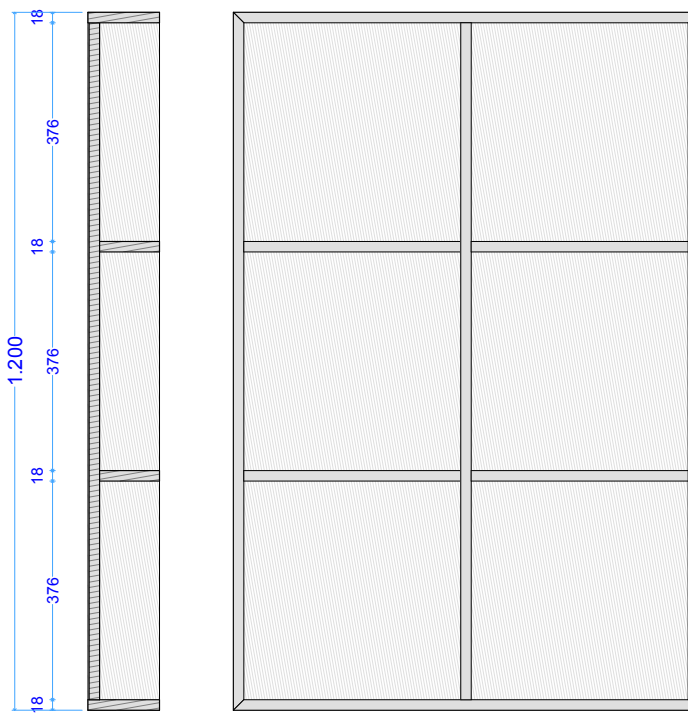
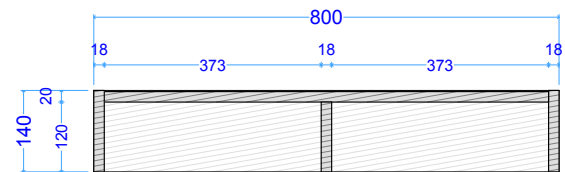

R6GI080120__

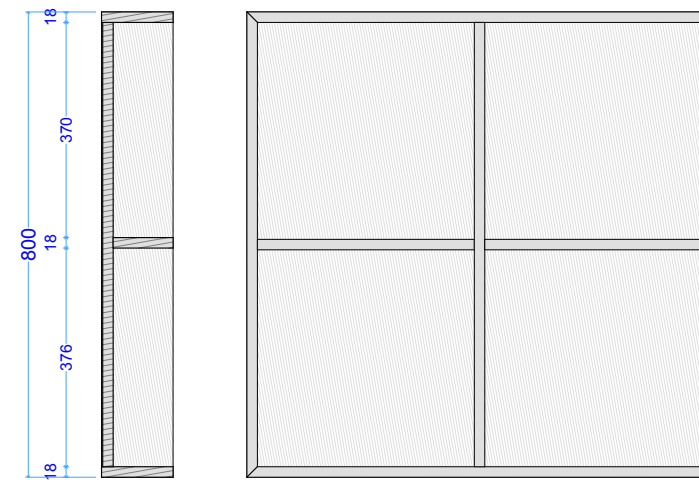
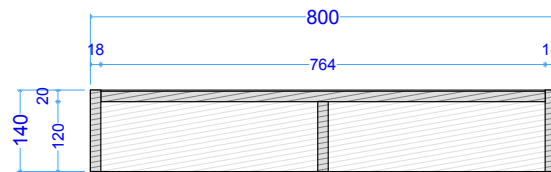

R6GI080080__

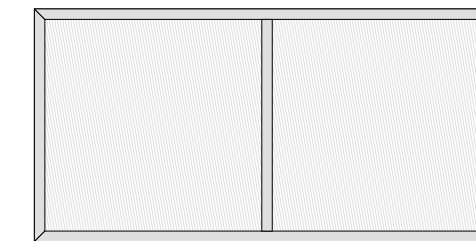
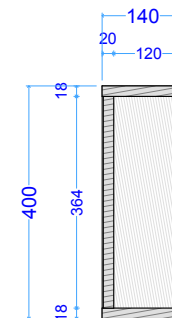

R6GI080040__

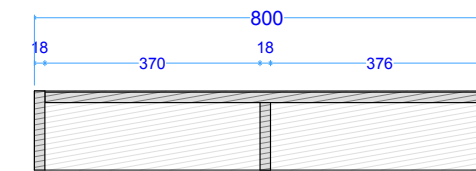
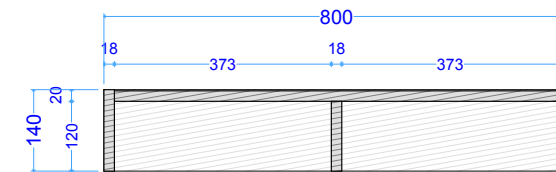

REPLAY - pensile 80 verticale a notte

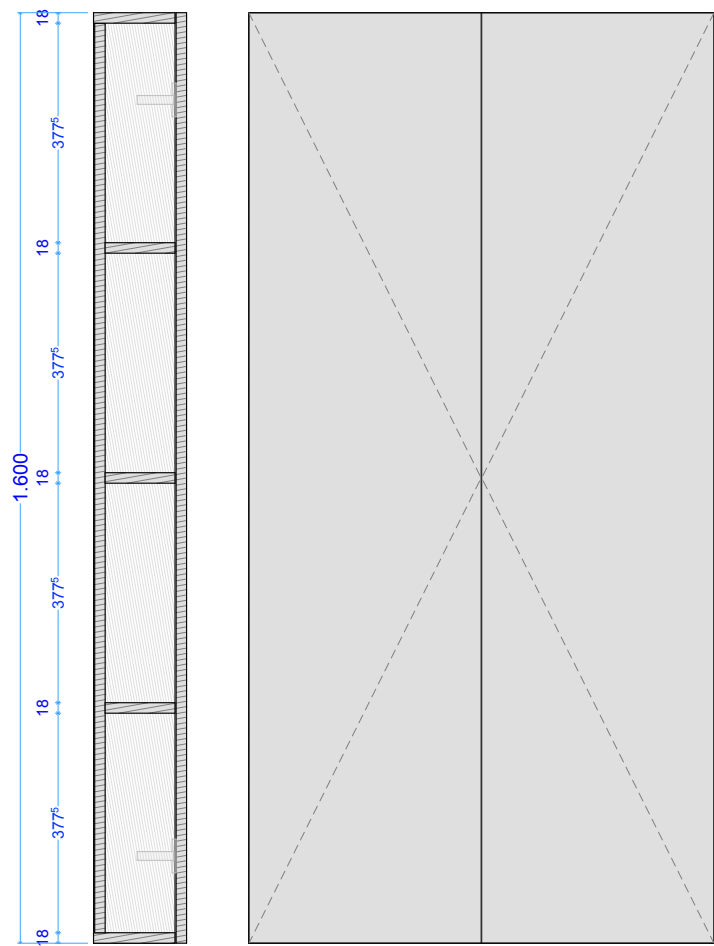

R6GI080160_

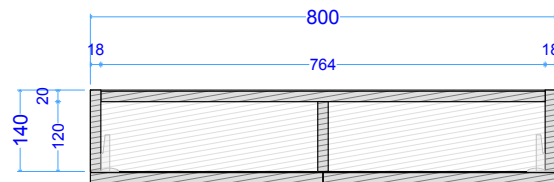
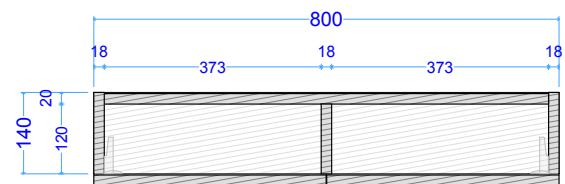

R6GI080120_

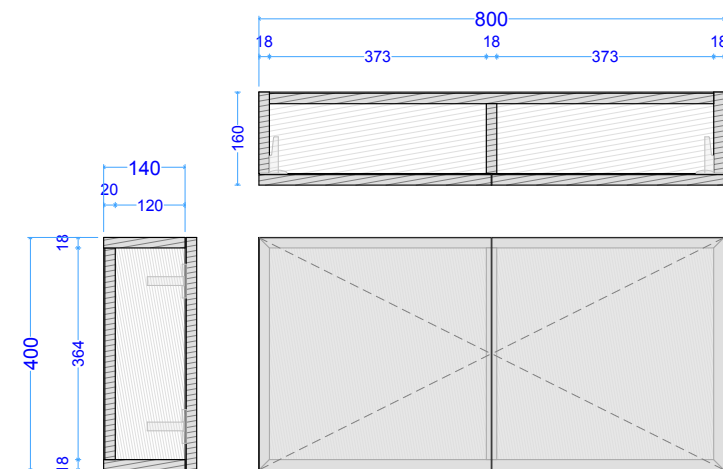
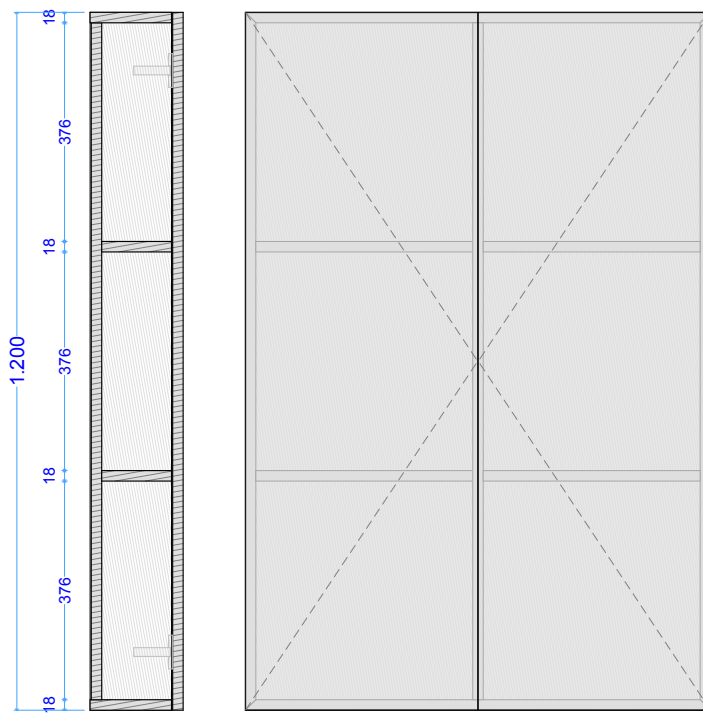

R6GI080040_

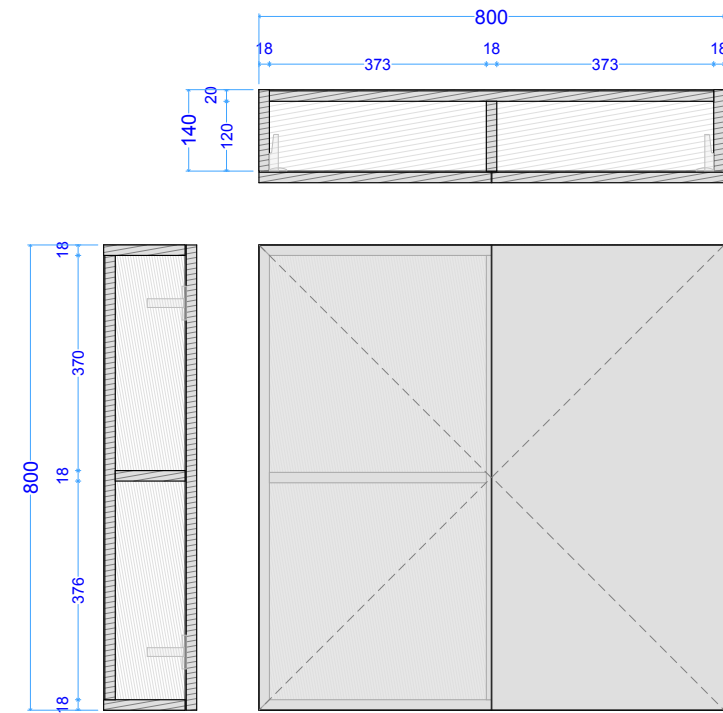

R6GI080080_

REPLAY - pensile 80 verticale a giorno/notte

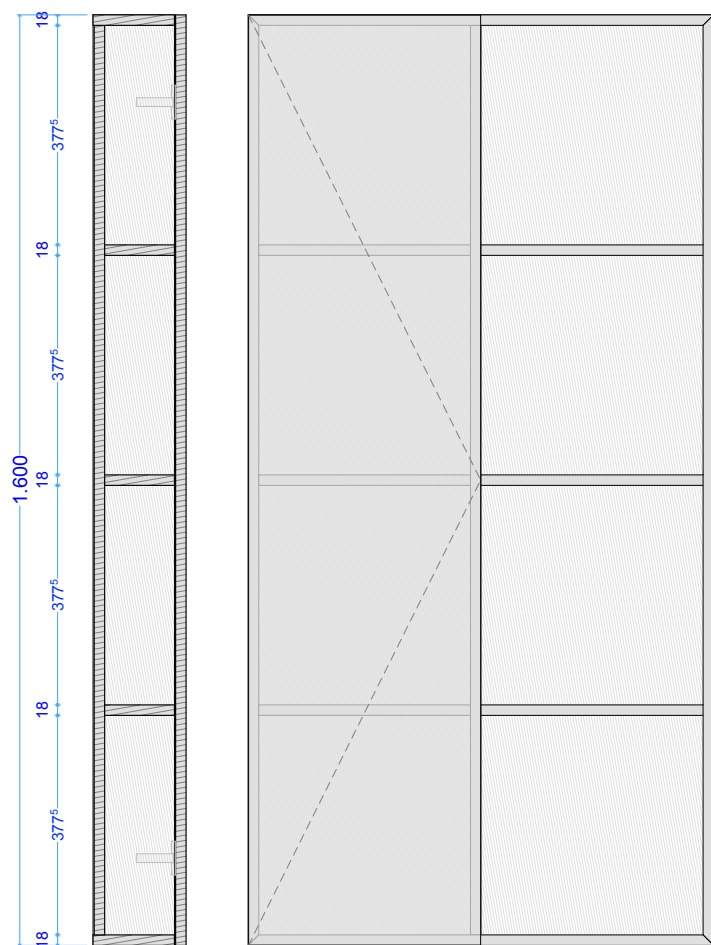

R6GI080160_

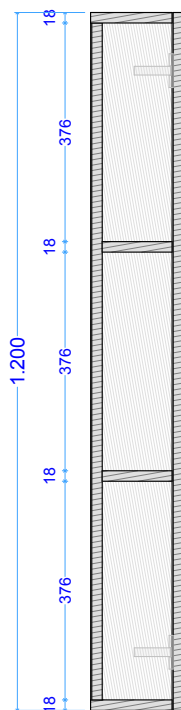
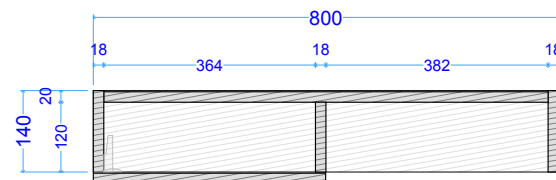

R6GI080120_

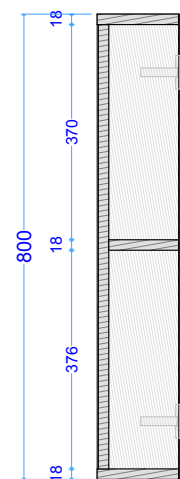
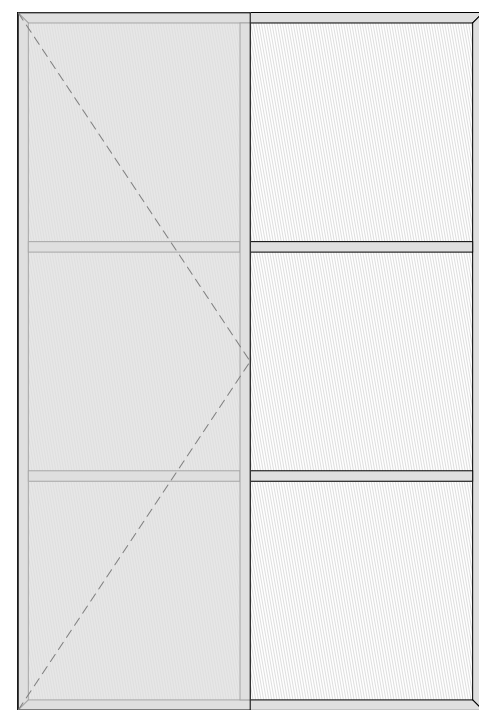
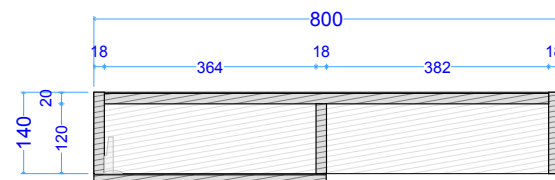

R6GI080080_

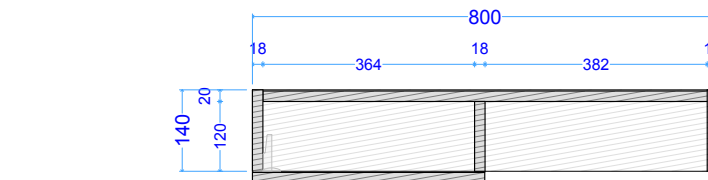

R6GI080040_

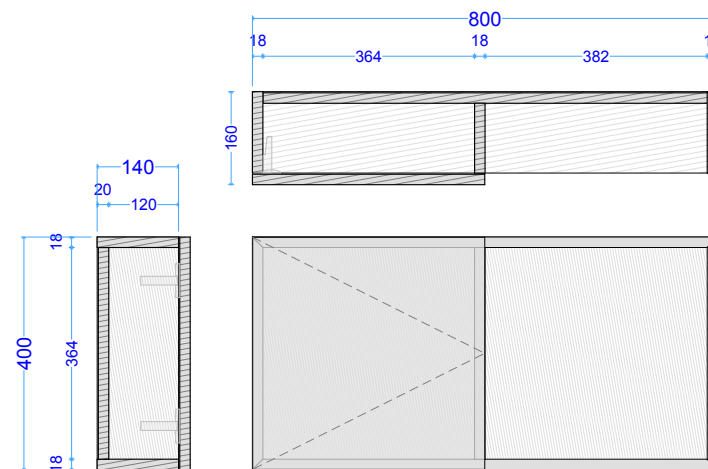

REPLAY - pensile 40 orizzontale a giorno v.01

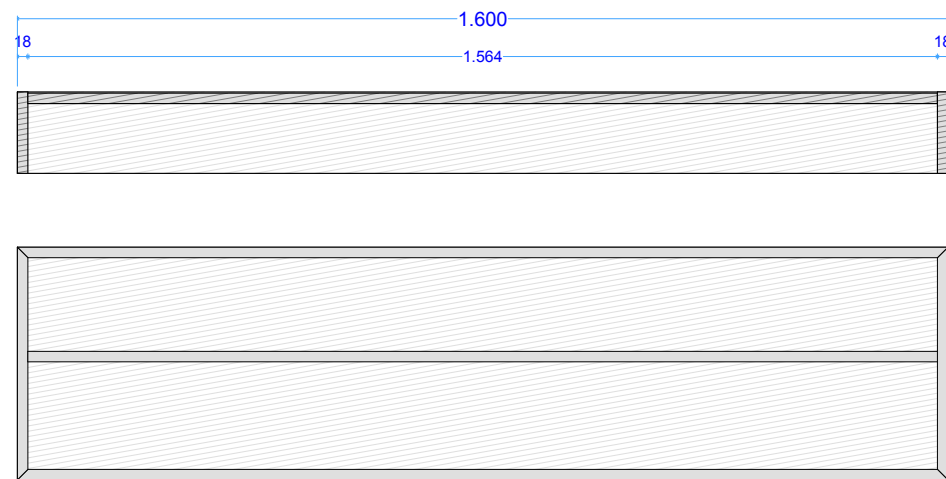
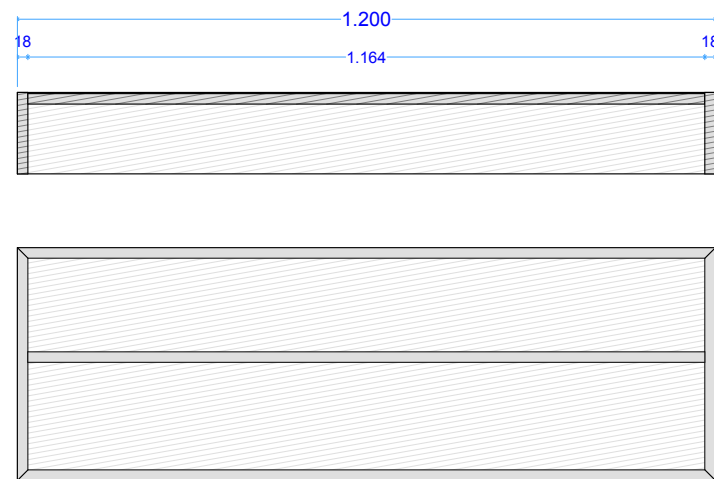
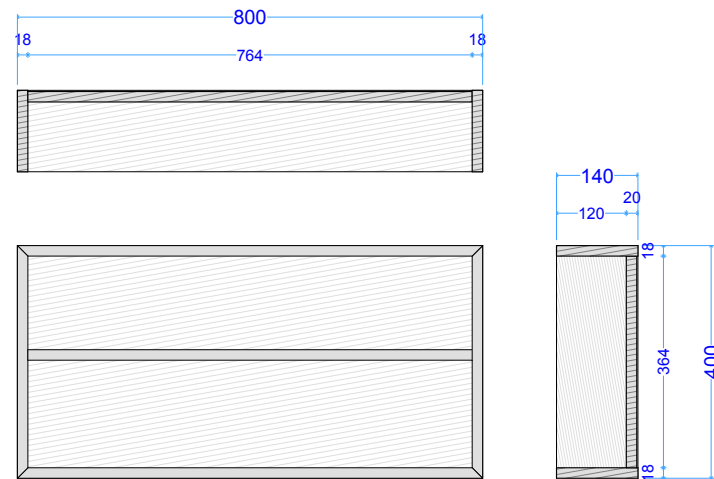

REPLAY - pensile 40 orizzontale a giorno v.02

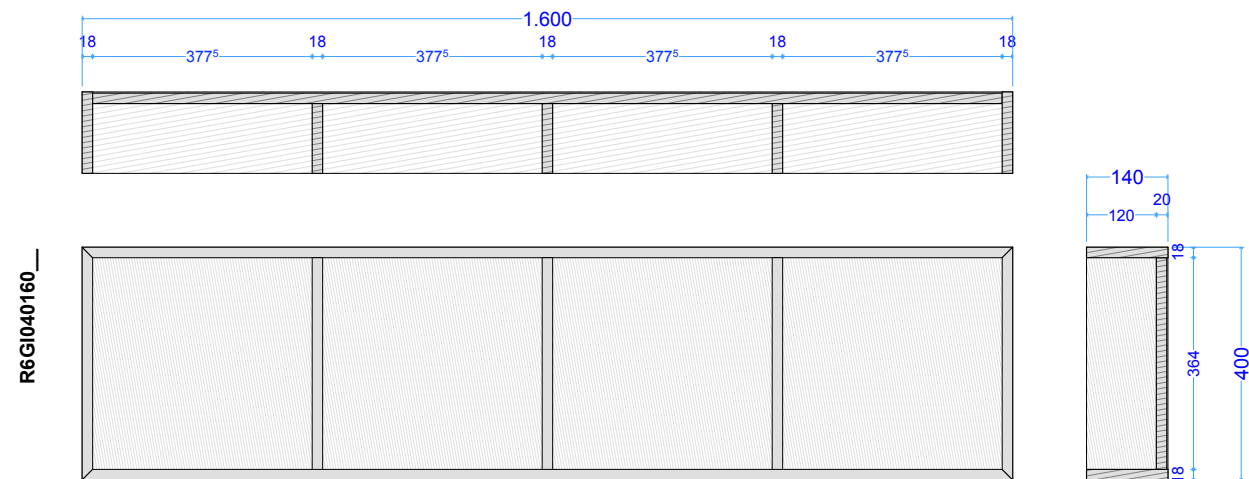
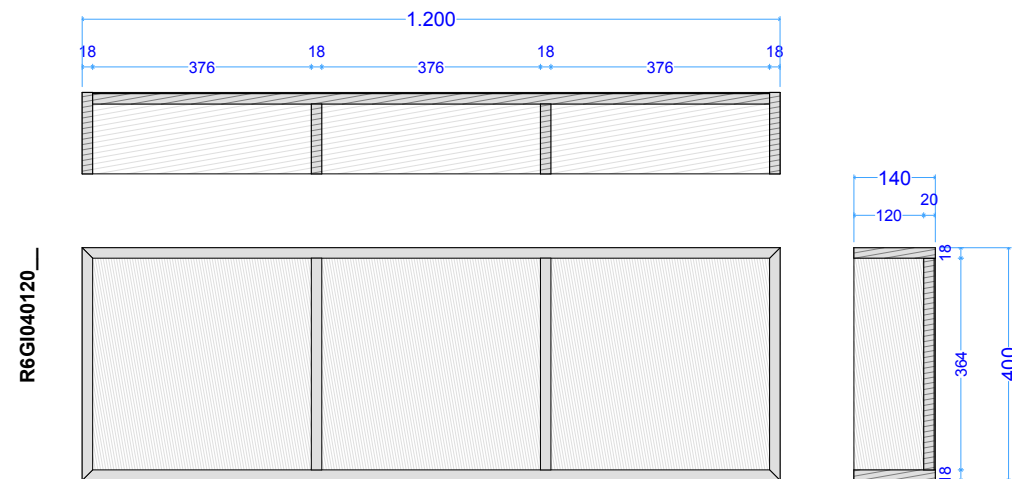
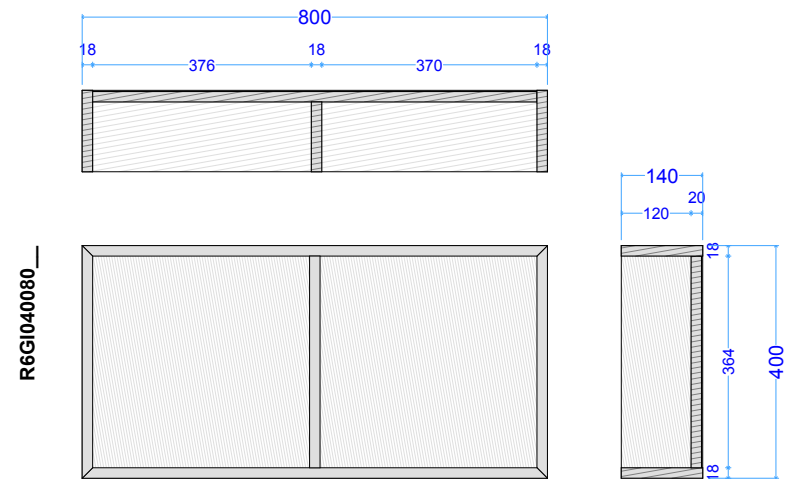

REPLAY - pensile 40 orizzontale a notte v.01

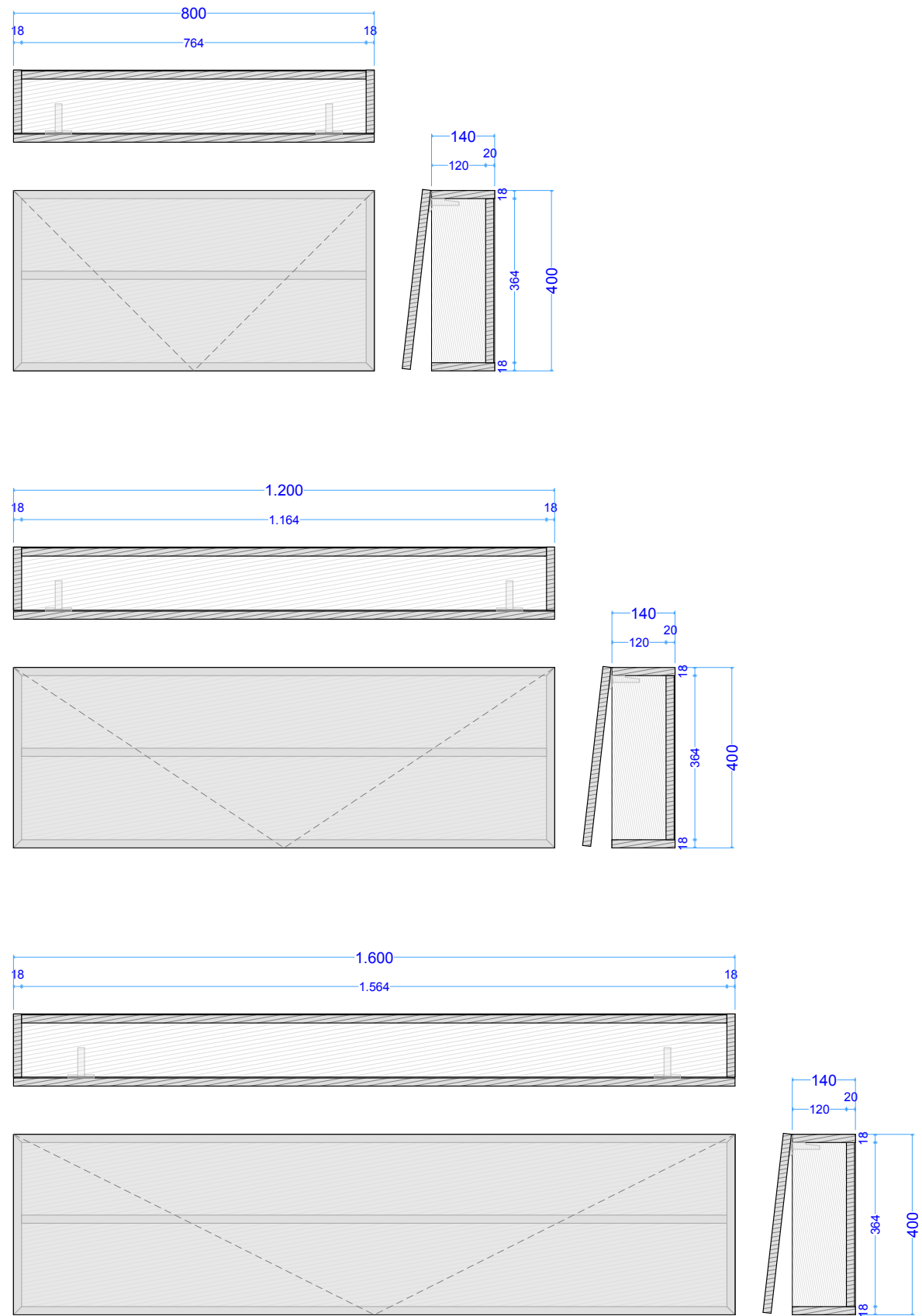

REPLAY - pensile 40 orizzontale a notte v.02

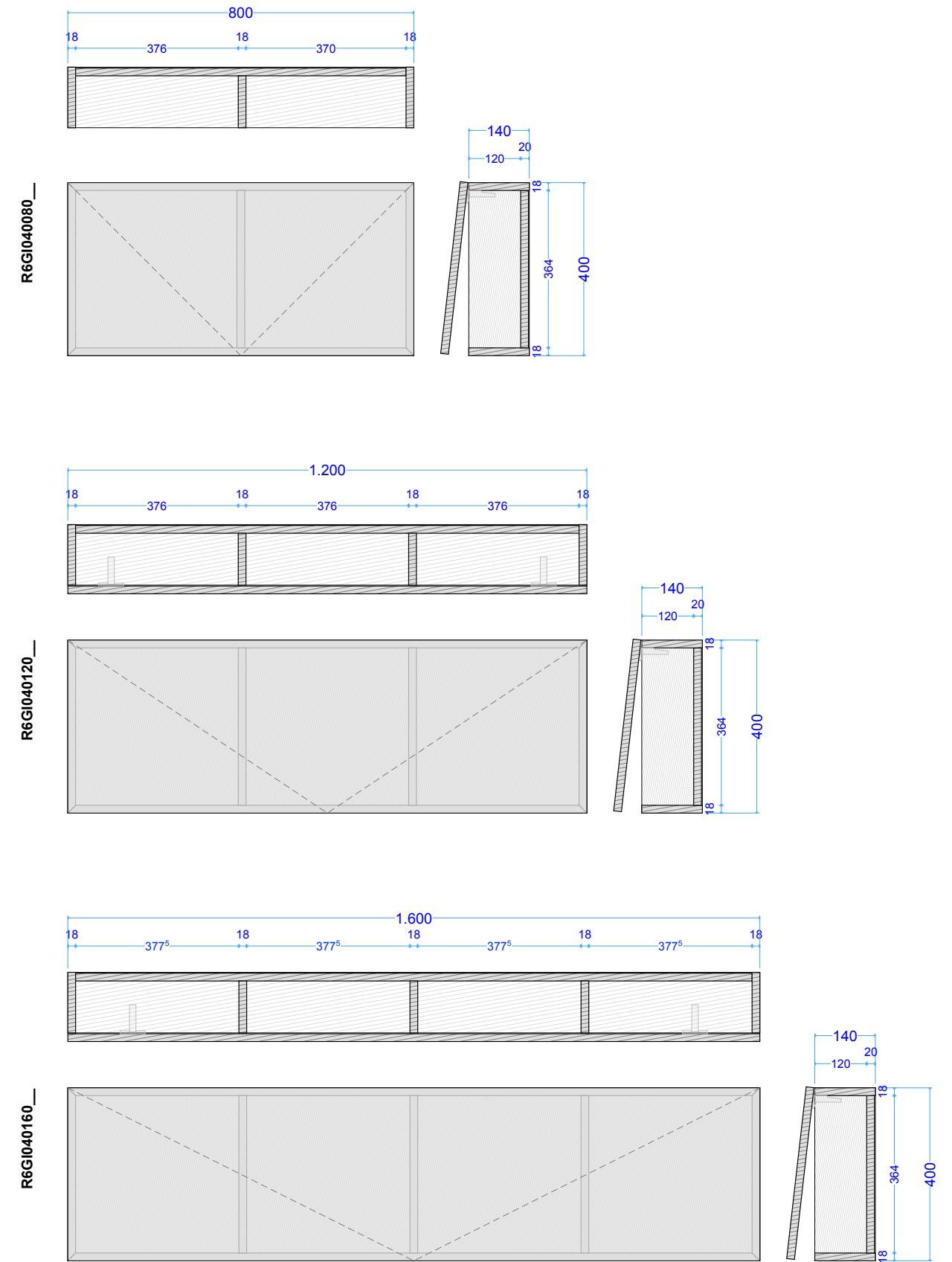

REPLAY - pensile 40 orizzontale a notte / giorno

REPLAY - pensile 40 orizzontale a notte / giorno

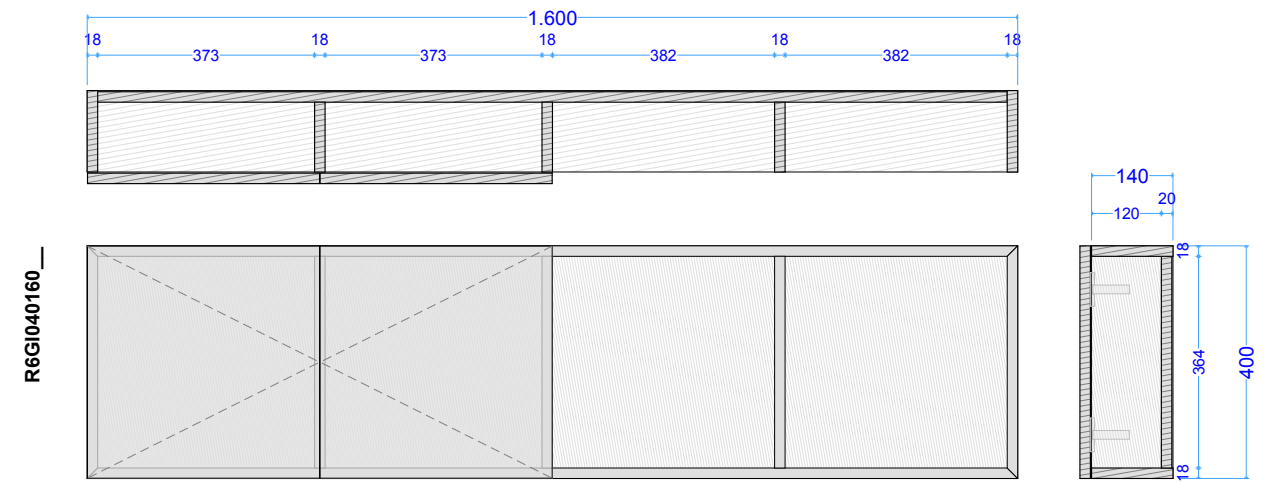
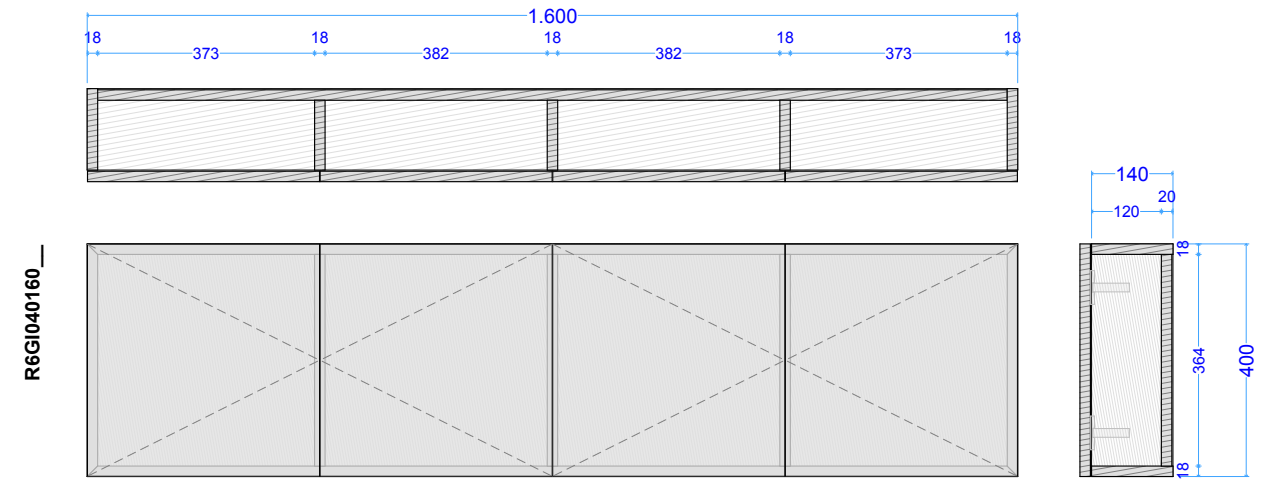
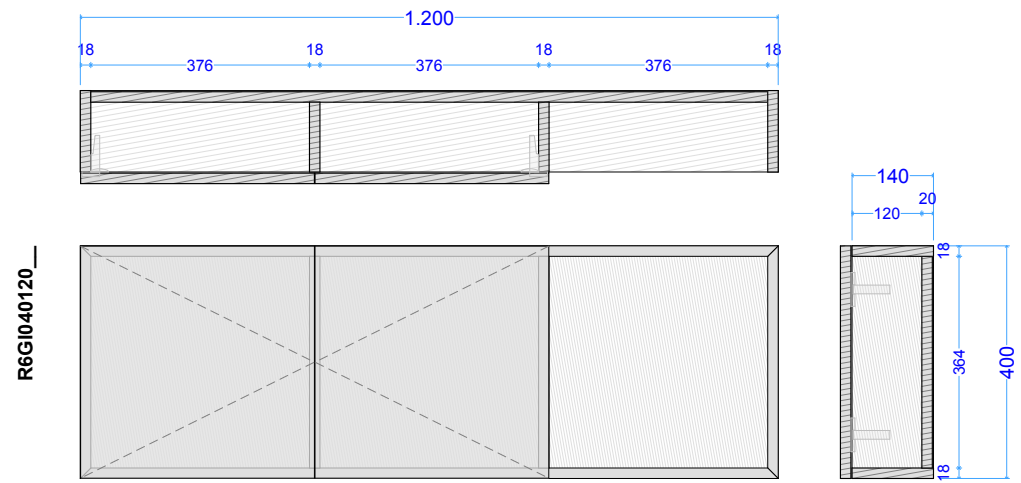
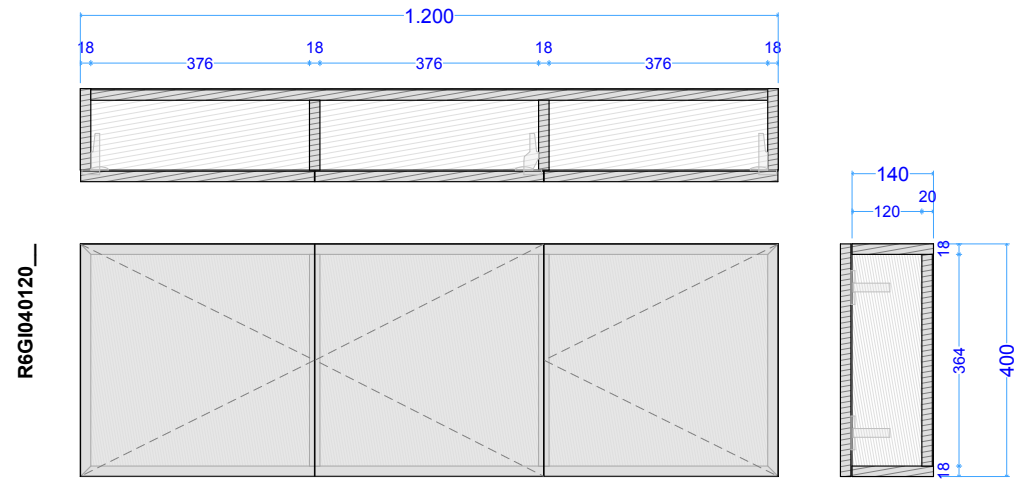

REPLAY - pensile 120 a giorno/notte

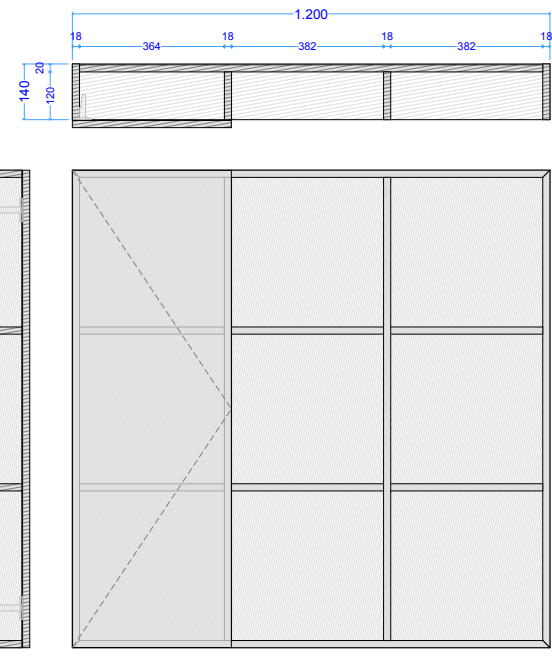
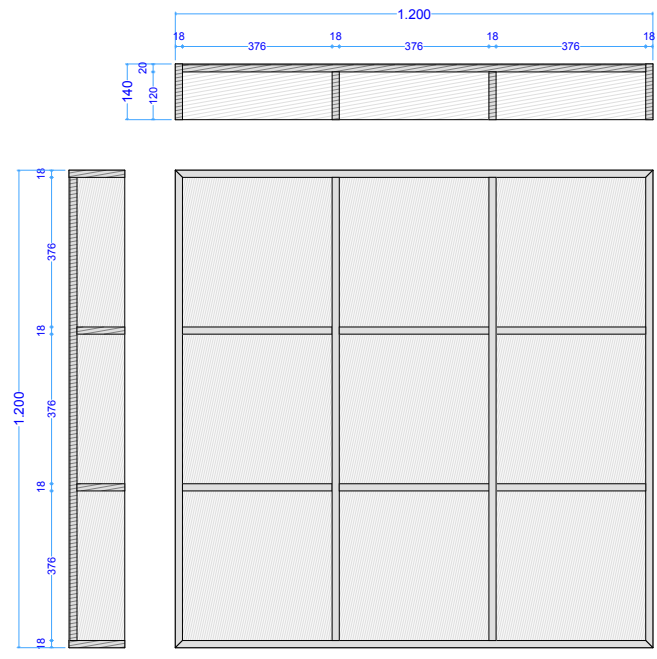

R6GI080120__

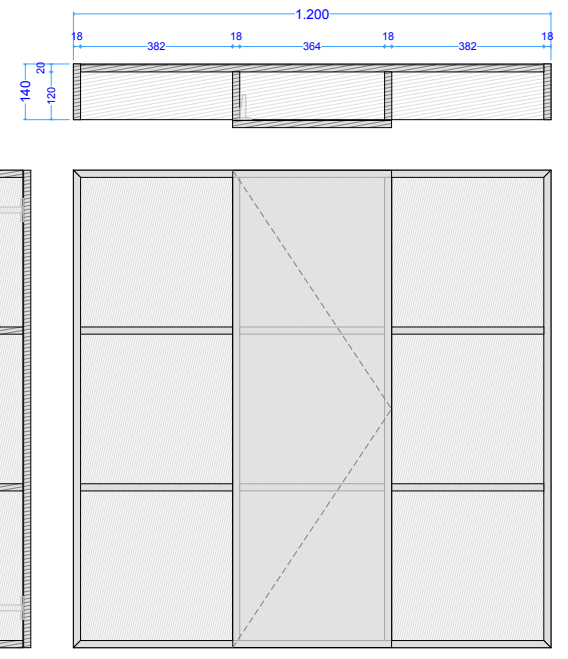

R6GI080120__

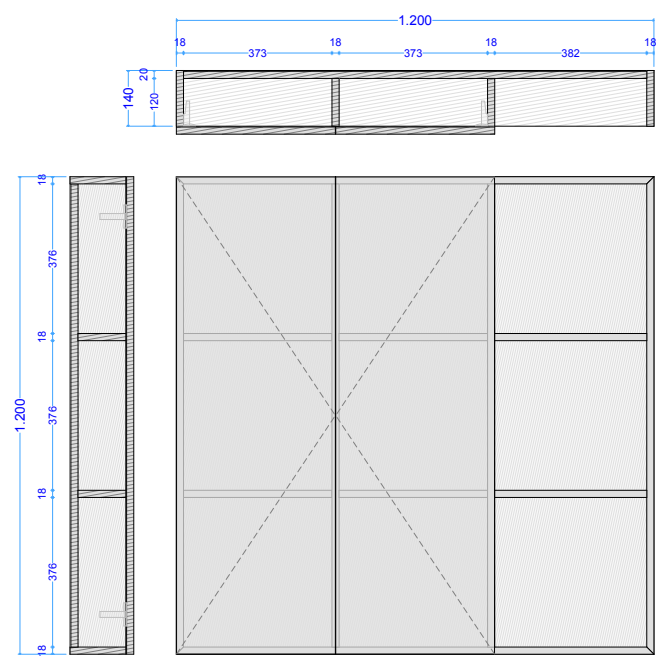

R6GI080120__

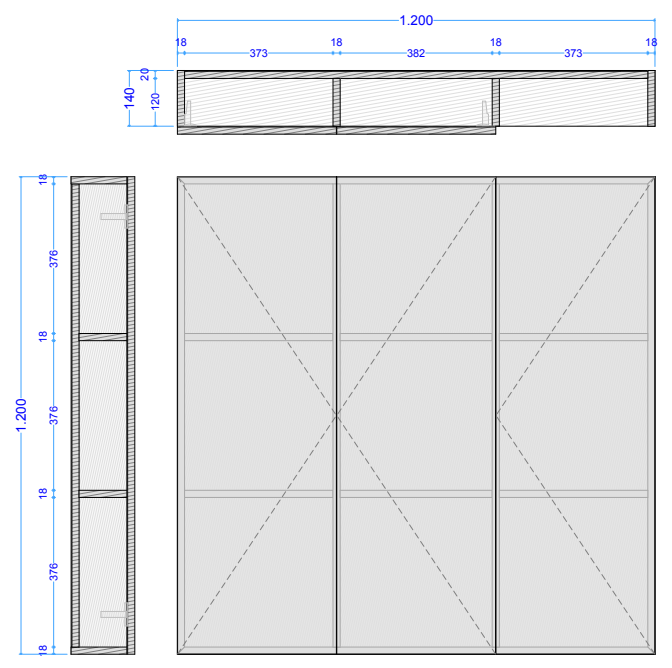

R6GI080120__

REPLAY - pensile 160 combinazione a giorno/notte

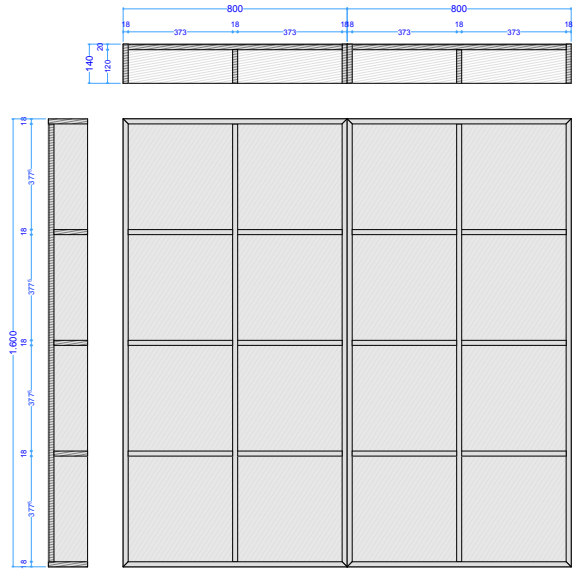

REGI080160_

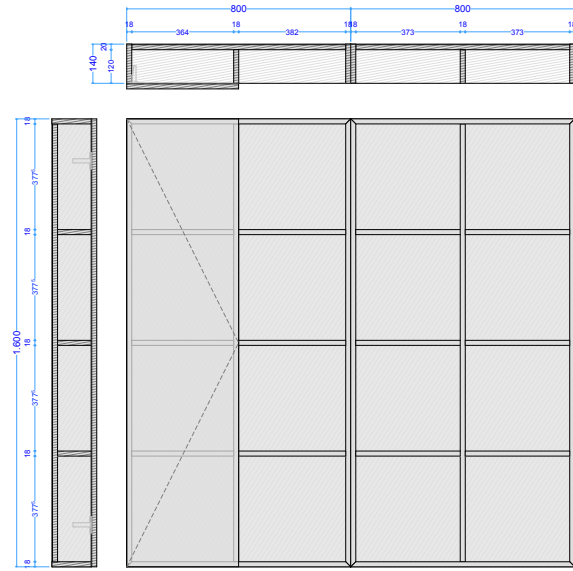

REGI080160_

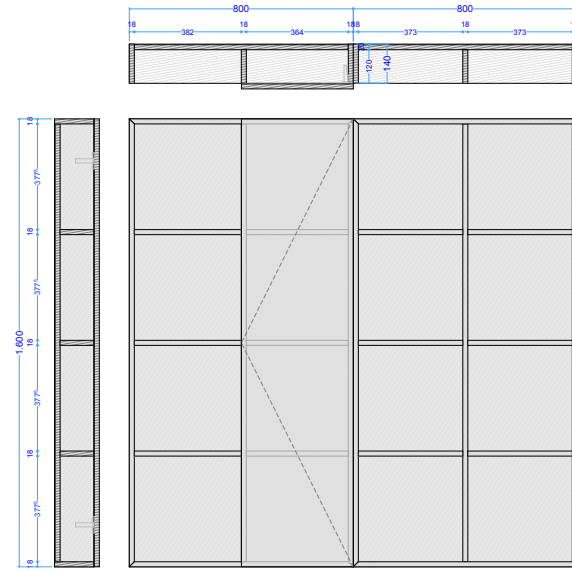

REGI080160_

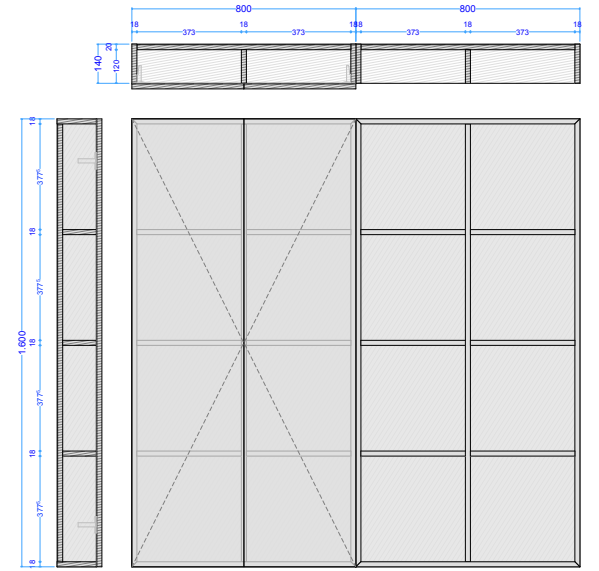

REGI080160_

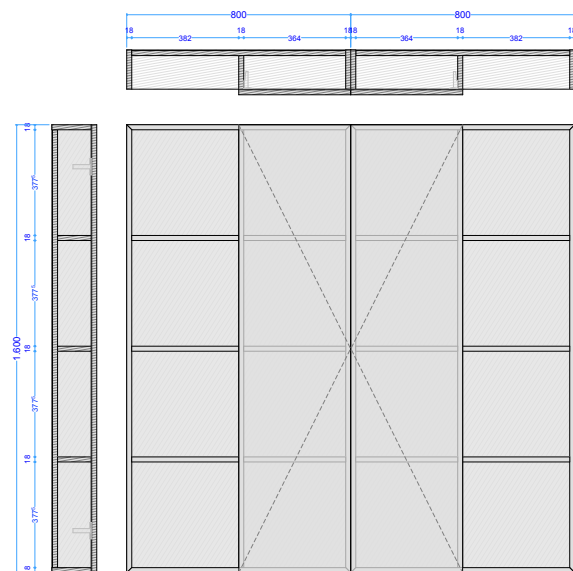

REGI080160_

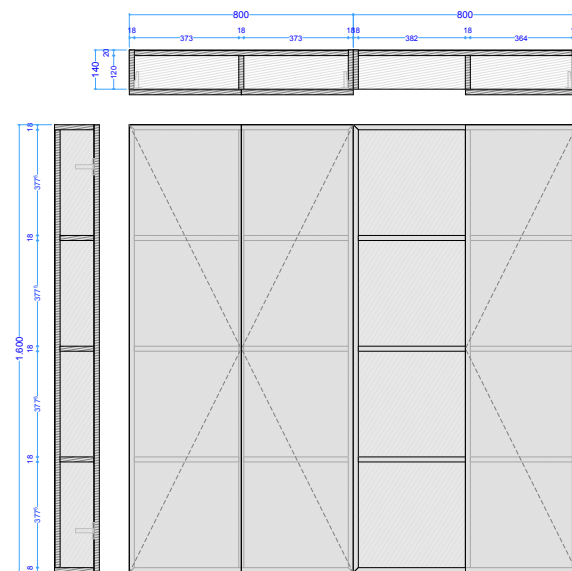

REGI080160_

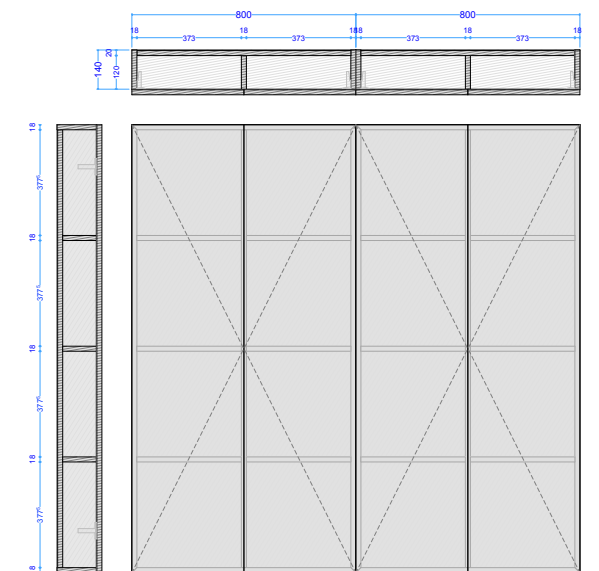

REGI080160_

REGI080160_