

STEEL _ piatto doccia in Acciaio / shower tray in stainless steel

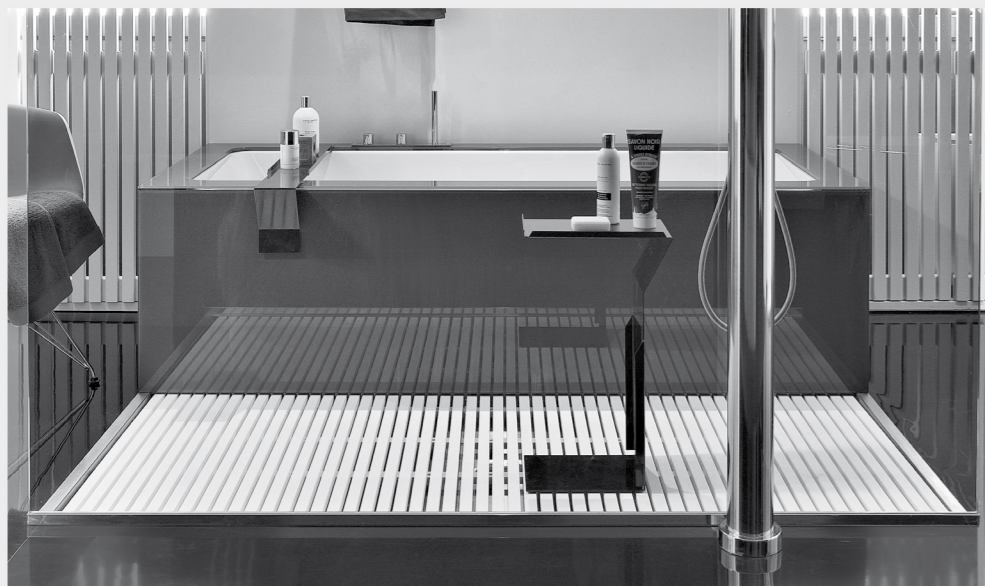

Piatto doccia in acciaio inossidabile AISI_304 con integrata pedanella listellare Deck in finitura Corian®, e in diverse essenze di legno termotrattato o con pedana listellare Full disponibile nella versione Corian® o in alluminio da rivestire.
È disponibile a misura al centimetro ed è installabile sia appoggio che a filo pavimento.

Steel is a shower tray in stainless steel AISI_304 with integrated slatted footboard DECK available in Corian® and in several thermo-treated wood finishes, or with footboard Full available in Corian or in aluminium to be clad. STEEL is produced to centimeter, and can be installed floor-flush and floor standing

SPECIFICHE TECNICHE / technical features

PIATTO DOCCIA SINGOLO

a misura al cm da 60 x 60 a 210 x 110 cm
altezza bacino 65 mm

PIATTO DOCCIA DOPPIO LINEARE

a misura al cm fino a 360 x 110 cm
altezza bacino 65 mm

PIATTO DOCCIA DOPPIO FRONTALE

a misura al cm fino a 210 x 220 cm
altezza bacino 65 mm

MATERIALE

bacino in acciaio inossidabile AISI_304 con pendenza prefornata
supporto inferiore del bacino in EPS con funzioni di isolamento termico / acustico e livellamento piano sul massetto

PILETTA

piletta sifonata H 60 mm con portata **24 lt / min**
piletta sifonata H 80 mm con portata **31 lt / min**
piletta sifonata H 50 mm con portata **44 lt / min**

SINGLE SHOWER TRAY

made-to-measure to centimeter from 60 x 60 to 210 x 110
tray's height 65 mm

DOUBLE LINEAR SHOWER TRAY

made-to-measure to centimeter up to 360 x 110
tray's height 65 mm

DOUBLE FRONTAL SHOWER TRAY

made-to-measure to centimeter up to 210 x 220
tray's height 65 mm

MATERIAL

shower tray in stainless steel AISI_304 with integrated slope
layer of pse on the tray's bottom side to grant thermo and acoustic isolation and leveling on the screed

WASTE

waste with siphon h. 60 mm with flow rate 24 lt/min
waste with siphon h. 80 mm with flow rate 31 lt/min
waste with siphon h. 50 mm with flow rate 44 lt/min

MODI DI INSTALLAZIONE / installation

FILOPAVIMENTO / floor flush

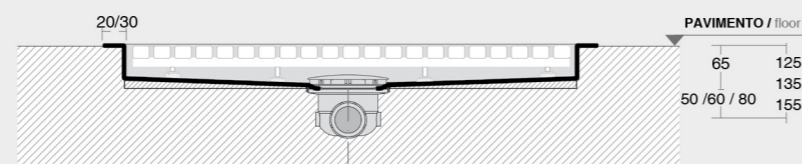
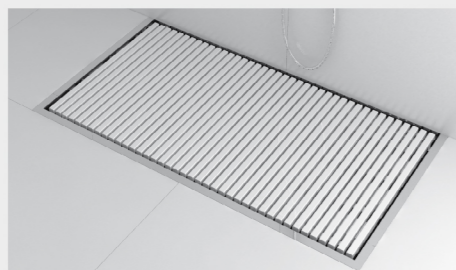

APPOGGIO / floor-standing

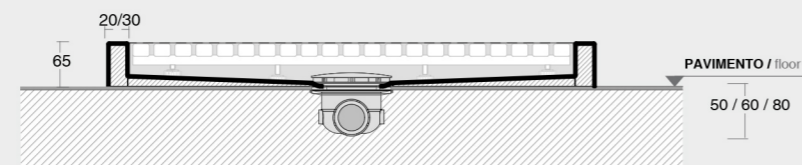
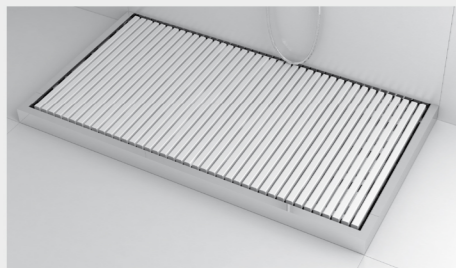

KIT

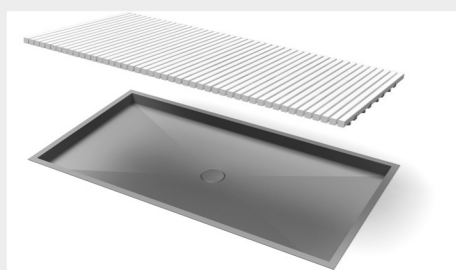

Ordine: compilare il MODULO D'ORDINE per piatto doccia STEEL e pedana DECK (pag.400 e scaricabile dal sito www.makro.it)
please fill in the ORDER FORM to order the STEEL shower tray and footboard DECK (pg.400 or download from www.makro.it)

PIATTO DOCCIA a misura / made to measure base

singolo / single tray

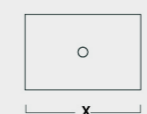
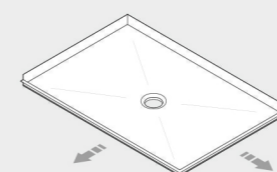

X - Y
fino a 210 - 110 cm
up to

doppio laterale / lateral double tray

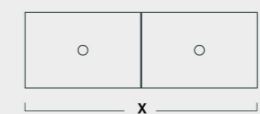
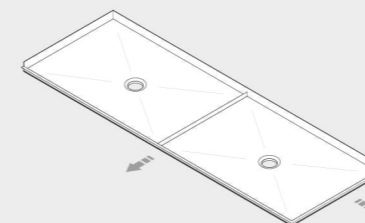

X - Y
fino a 360 - 110 cm
up to

doppio frontale / frontal double tray

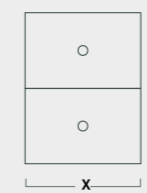
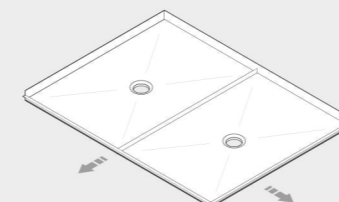

X - Y
fino a 210 - 220 cm
up to

pedane / footboards

deck

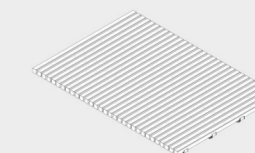

Pedanella DECK a doghe H 49 mm con piedini regolabili disponibile in Corian® / Legno TT
DECK slatted footboard H 49 mm with adjustable feet available in finish Corian® / TT wood

full

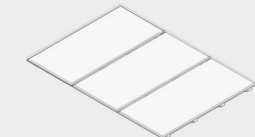

Pedana FULL a misura in ALLUMINIO DA RIVESTIRE altezza minima 36 mm
made-to-measure footboard FULL minimum height 36 mm in ALUMINIUM TO BE CLAD
Pedana FULL a misura in CORIAN® altezza minima 44 mm
made-to-measure footboard FULL minimum height 44 mm in CORIAN®

Si consiglia di effettuare l'ORDINE della pedana a rivestimento effettuato.
we recommend to place the order of the footboard once the cladding is placed.

Per ordinare la pedana DECK / FULL compilare il MODULO D'ORDINE (rif. pag.401 o scaricabile dal sito www.makro.it)
please fill in the ORDER FORM to order the deck / full footboard (pg.401 or download from www.makro.it).

DOTAZIONE KIT / shower tray kit

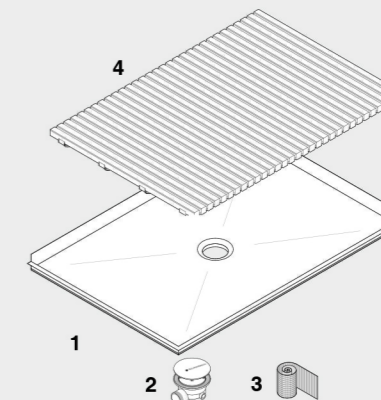

1. bacino in acciaio inox AISI_304
2. piletta sifonata (24 - 31 - 44 lt / min)
3. 3mt di rete di ancoraggio
4. pedana deck/full (opzionale)

1. tray in stainless steel AISI 304
2. waste with siphon (24 - 31 - 44 lt / min)
3. 3mt anchoring mesh
4. deck/full footboard (optional)