

Elements TECHNOWALL

Modulo tecnico strutturale in technoPVC da rivestire
Structural technical wall in technoPVC

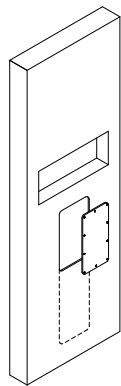

POSIZIONAMENTO / PLACEMENT

PARETE / wall

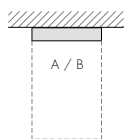

PENISOLA / wall short side

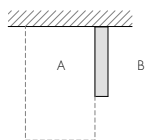

ISOLA / freestanding

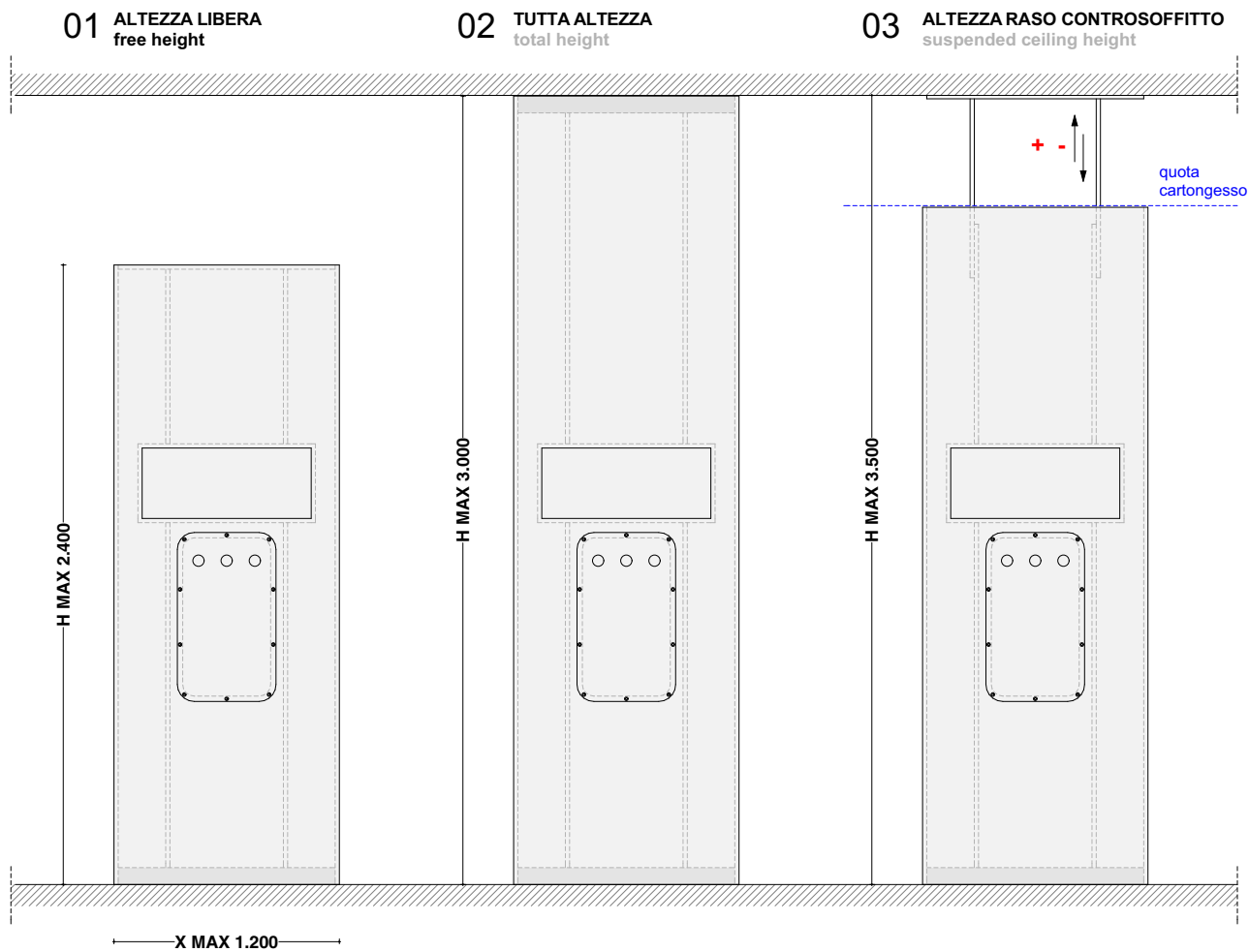
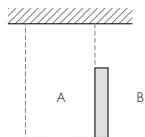

Elements TECHNOWALL

Modulo tecnico strutturale in technoPVC da rivestire
Structural technical wall in technoPVC

ALTEZZA LIBERA / FREE HEIGHT

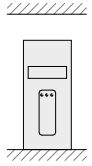

ISOLA / FREESTANDING

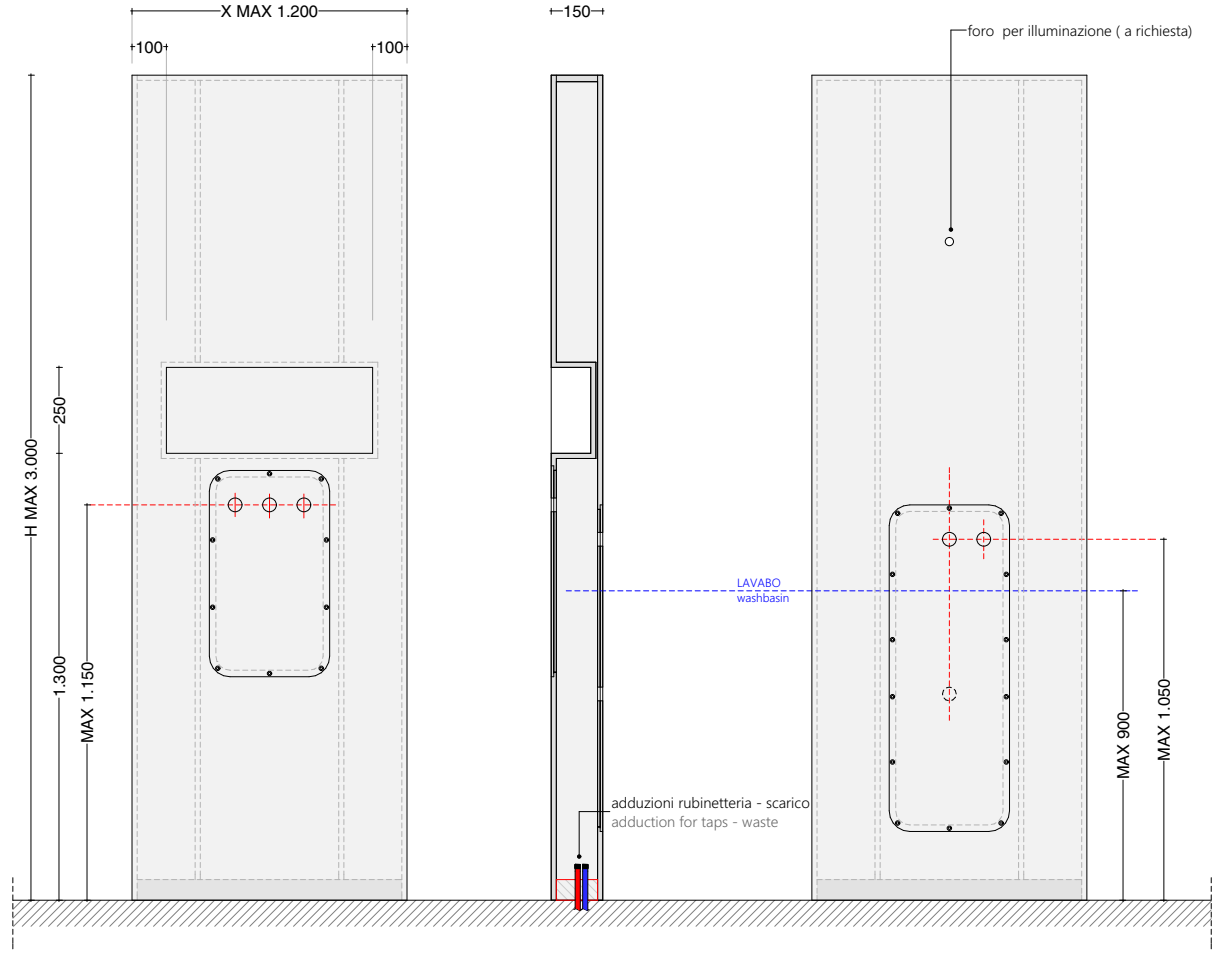
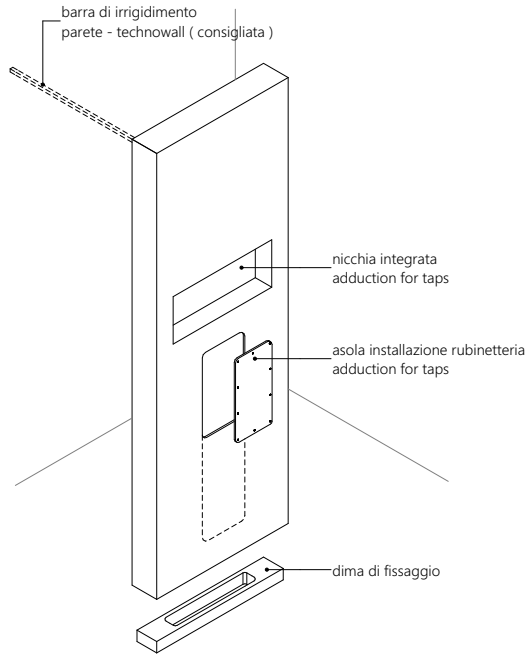
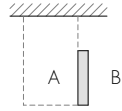

A - LATO DOCCIA / SHOWERTRAY SIDE

B - LATO LAVABO / WASHBASIN SIDE

COLLANTI / GLUES :

MAPEI KERALASTIC / KERAKOLL H40 EXTREME
o similari direttamente su technoPVC / directly on the technoPVC.

Nel caso si utilizzino collanti diversi o rivestimenti in cemento-resina è necessaria l'applicazione di Primer.
In case different glues are used or cement/resin claddings are applied, the use of a Primer is mandatory.

ATTENZIONE: Collaudare i collegamenti idraulici prima della posa dei rivestimenti/resinatura.

CAREFULL: Test the hydraulic connections before laying the finishing/resin.

Elements TECHNOWALL

Modulo tecnico strutturale in technoPVC da rivestire
Structural technical wall in technoPVC

TUTTA ALTEZZA / TOTAL HEIGHT

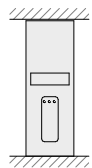

ISOLA / FREESTANDING

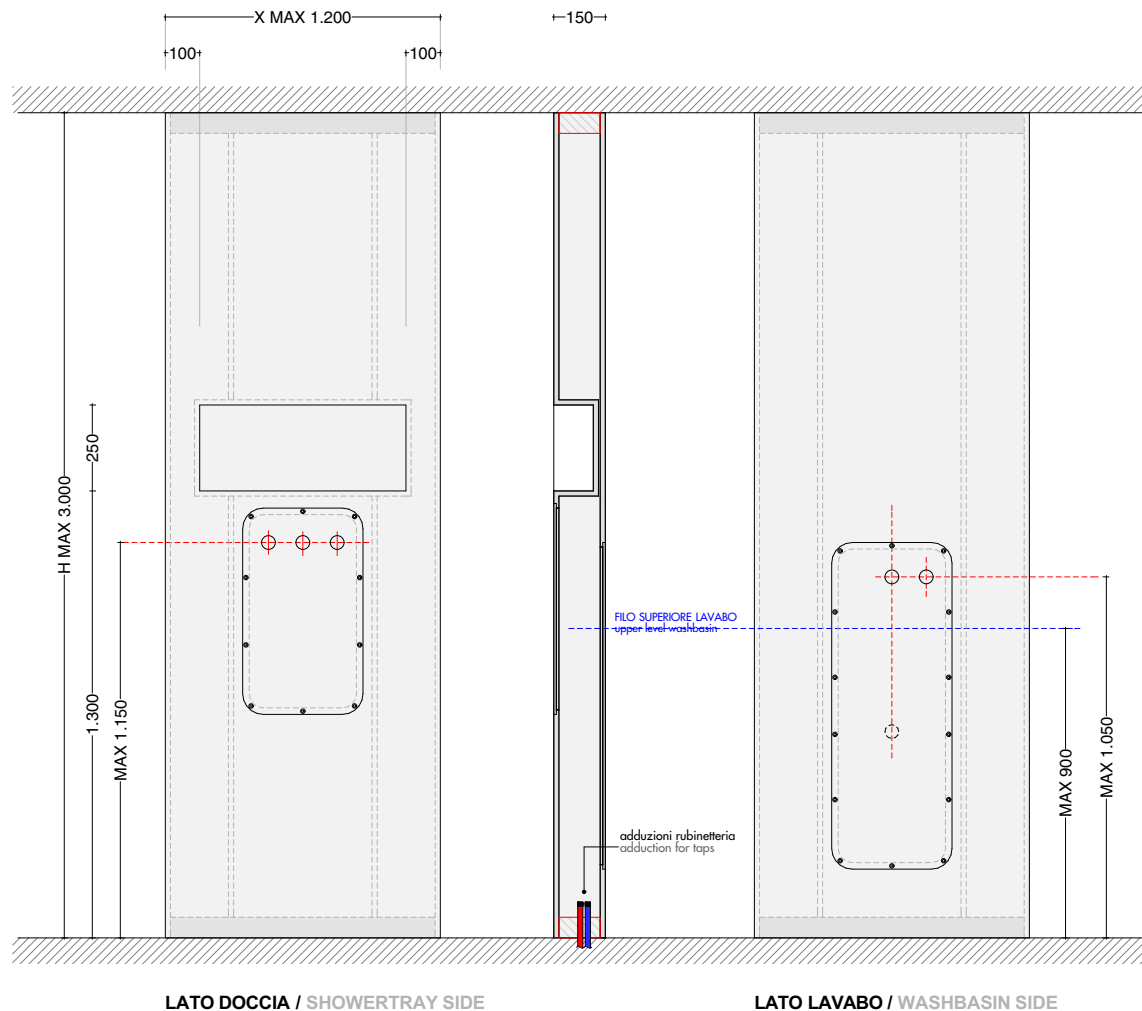
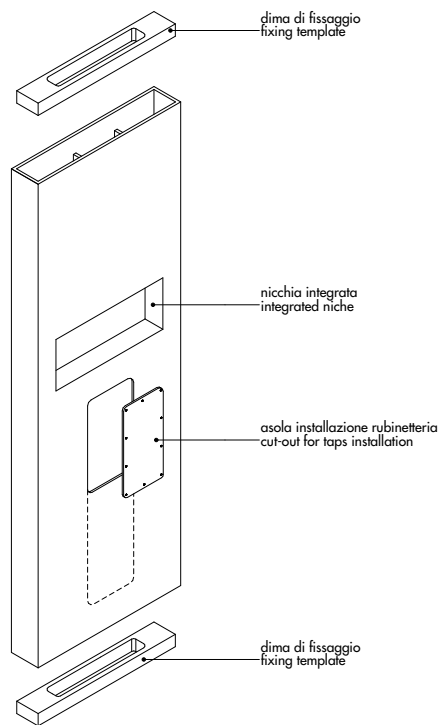
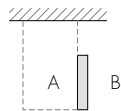

COLLANTI / GLUES :

MAPEI KERALASTIC / KERAKOLL H40 EXTREME
o similari direttamente su technoPVC / directly on the technoPVC.

Nel caso si utilizzino collanti diversi o rivestimenti in cemento-resina è necessaria l'applicazione di Primer.
In case different glues are used or cement/resin claddings are applied, the use of a Primer is mandatory.

ATTENZIONE: Collaudare i collegamenti idraulici prima della posa dei rivestimenti/resinatura.

CAREFULL: Test the hydraulic connections before laying the finishing/resin.

Elements TECHNOWALL

Modulo tecnico strutturale in technoPVC da rivestire
Structural technical wall in technoPVC

ALTEZZA RASO CONTROSOFFITTO /
SUSPENDED CEILING HEIGHT

ISOLA / FREESTANDING

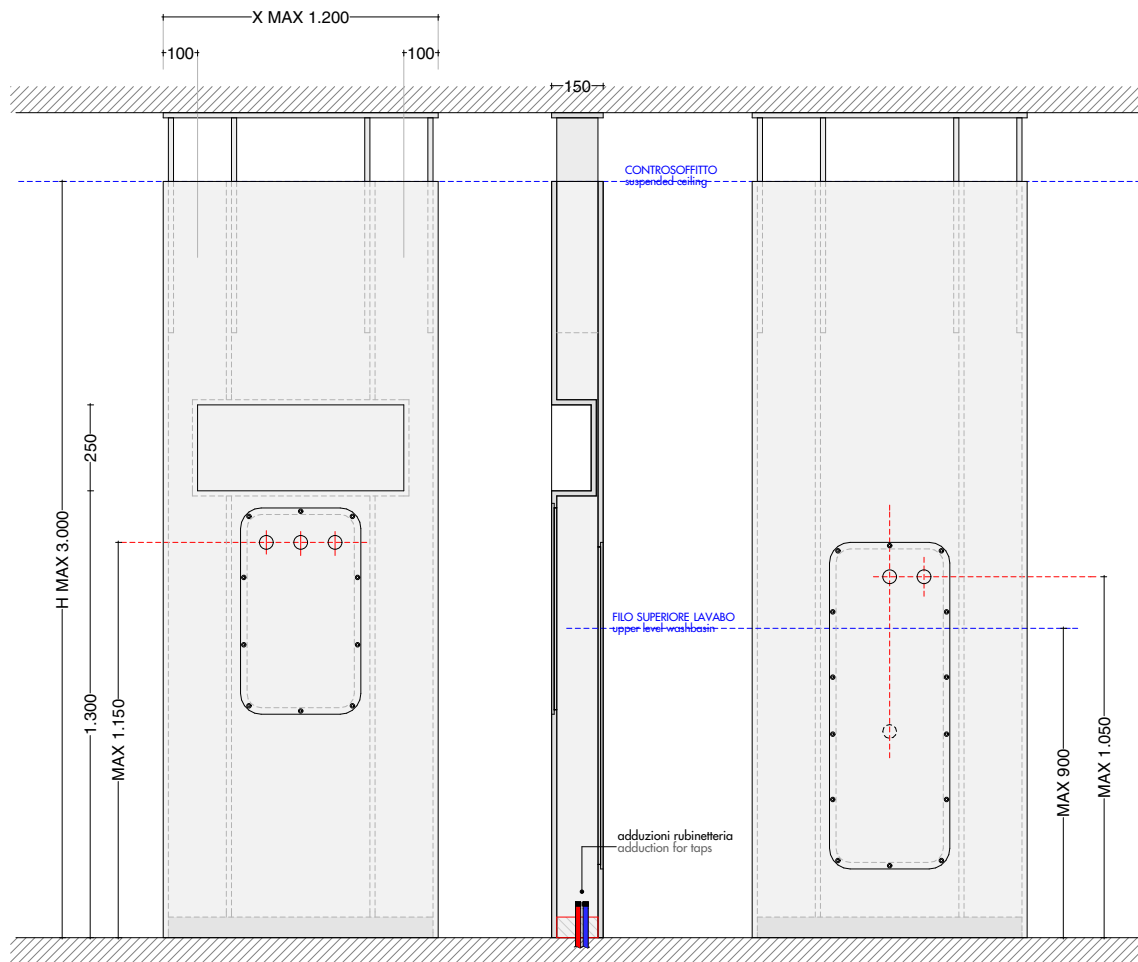
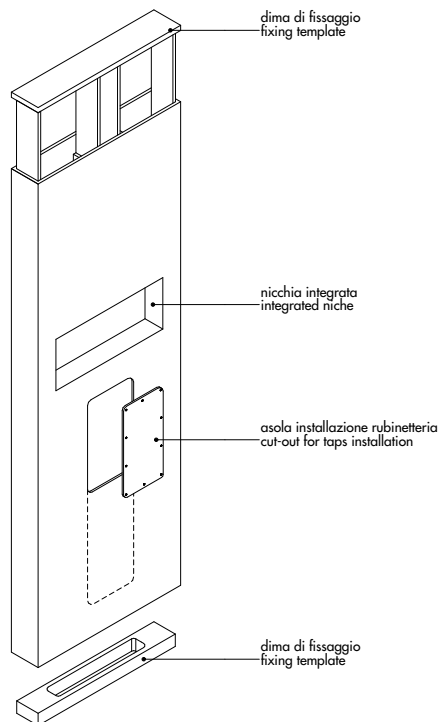
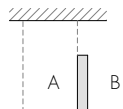
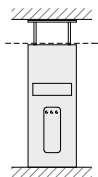

LATO DOCCIA / SHOWERTRAY SIDE

LATO LAVABO / WASHBASIN SIDE

COLLANTI / GLUES :

MAPEI KERALASTIC / KERAKOLL H40 EXTREME
o similari direttamente su technoPVC / directly on the technoPVC.

Nel caso si utilizzino collanti diversi o rivestimenti in cemento-resina è necessaria l'applicazione di Primer.
In case different glues are used or cement/resin claddings are applied, the use of a Primer is mandatory.

ATTENZIONE: Collaudare i collegamenti idraulici prima della posa dei rivestimenti/resinatura.

CAREFULL: Test the hydraulic connections before laying the finishing/resin.