

SLIM_assembly

Piatto doccia in CORIAN

Showertray in CORIAN

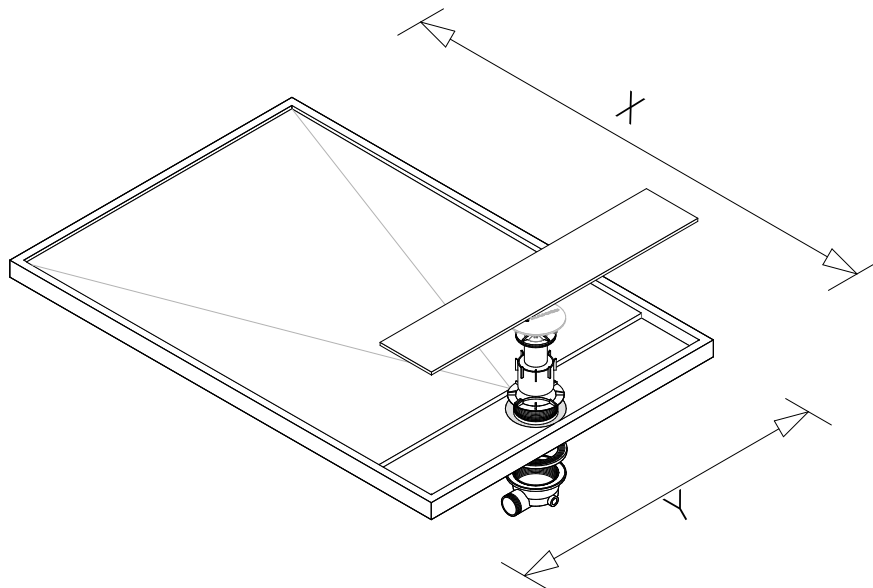

V.PIL.000.008.01

H. 80 mm
Ø 40 mm
31 l/m



V.PIL.000.006.01

H. 60 mm
Ø 40 mm
24 l/m



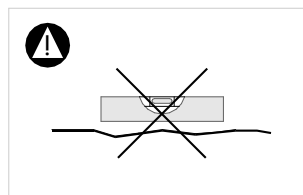
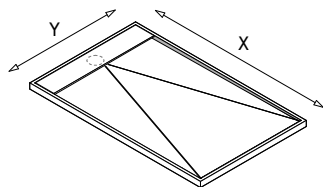
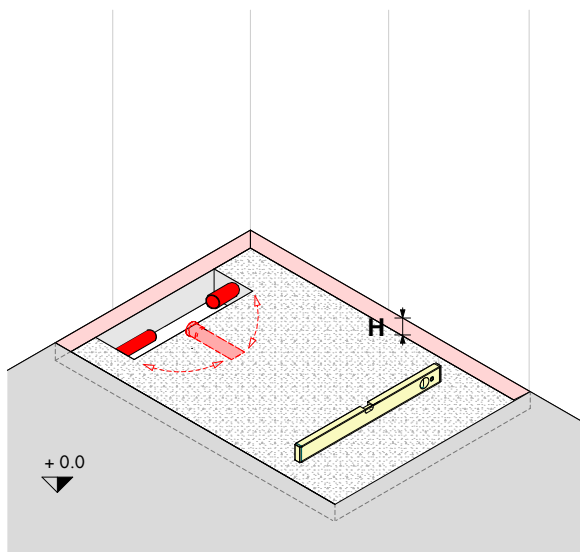

- ALTEZZA PIATTO DOCCIA / SHOWER TRAY HEIGHT

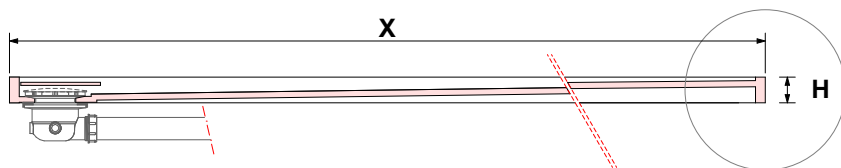

X cm	H cm
fino a / up to 180	4
maggiore / more than 180	5

H * Il valore riportato in tabella è da considerarsi indicativo. Non tiene conto di spessori d'incollaggio al massetto.

The value shown in this chart is approximate. Gluing thickness to the screed has not been considered.

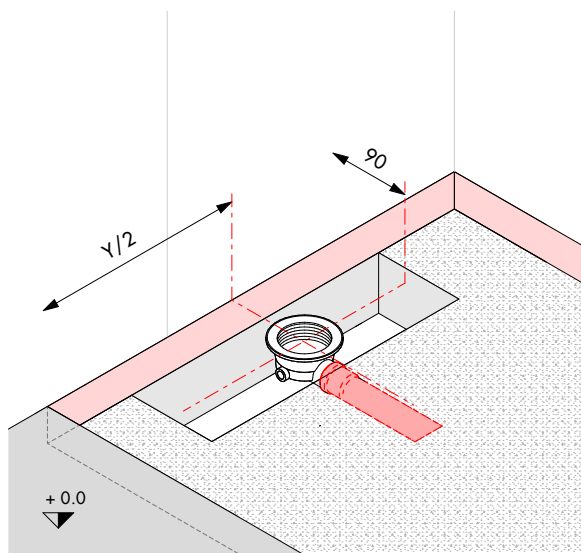

V.Pl.000.008.01 ___ H 80 mm

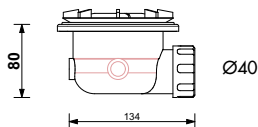

V.Pl.000.006.01 ___ H 60 mm

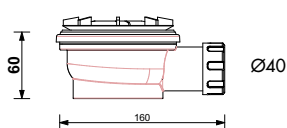

TIPOLOGIE INSTALLAZIONE / INSTALLATION TYPOLOGY

- appoggio / floor-standing

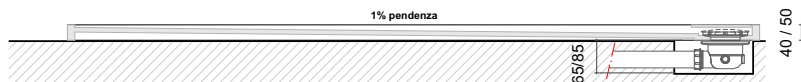

- filopavimento / floor-flush

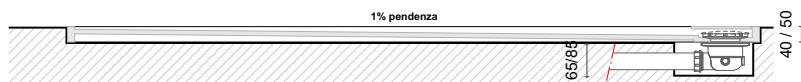

/ 03

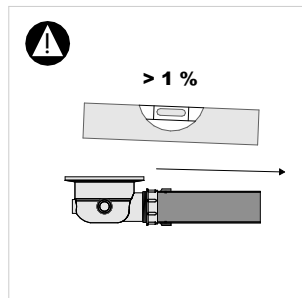
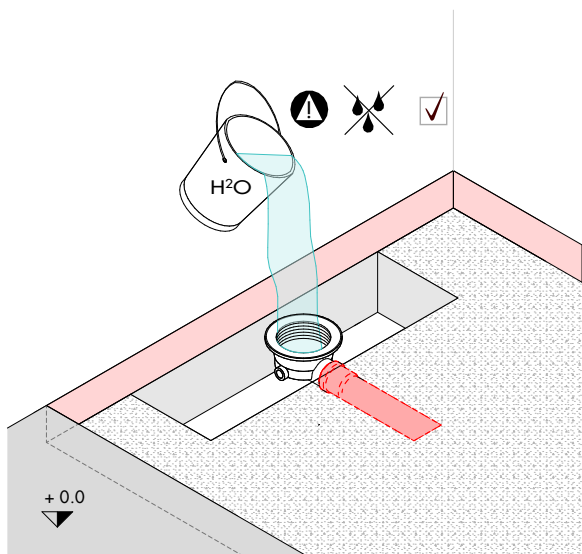

/ 04

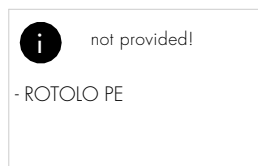
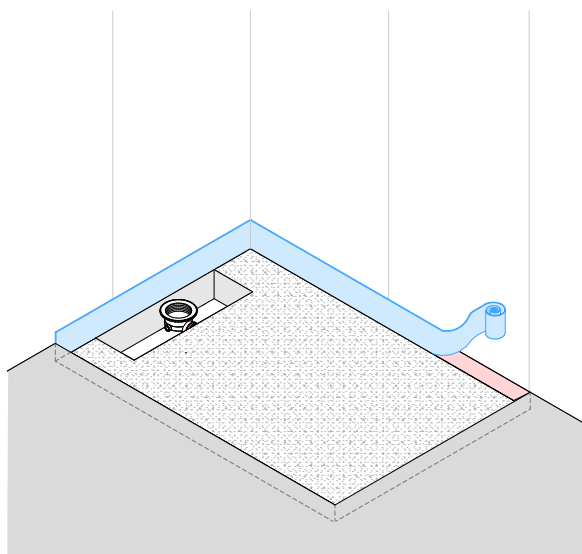

/ 05

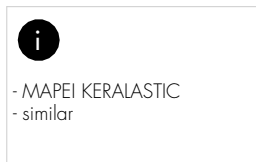
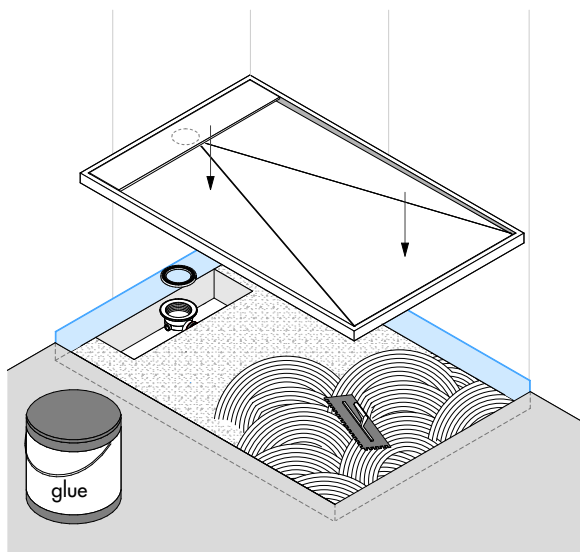

/ 06

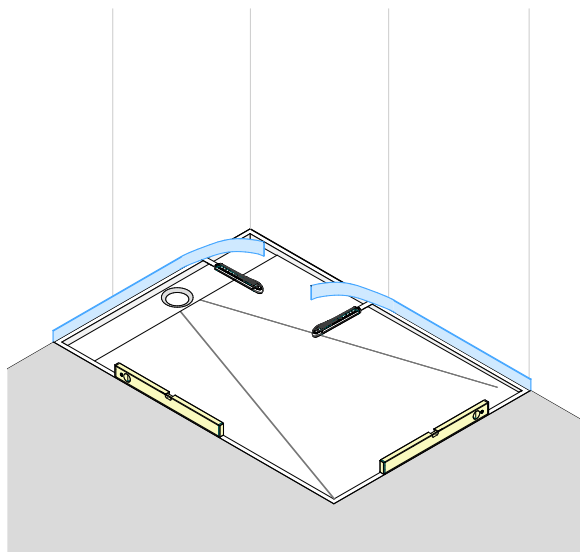

/ 07

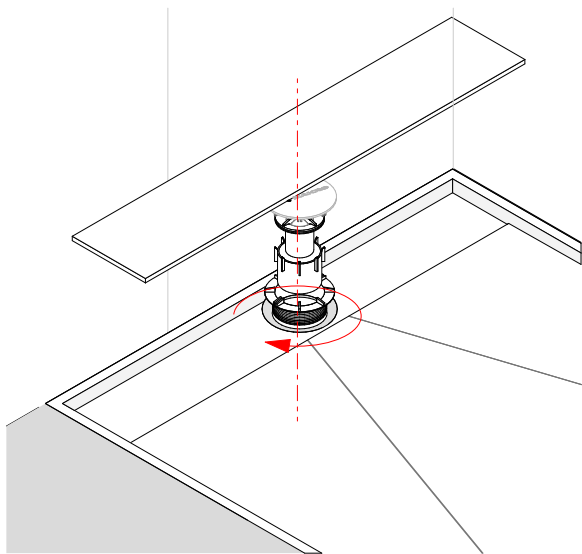

/ 08



24 h

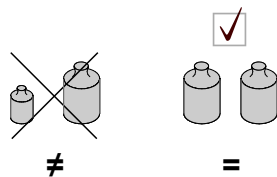

not provided!

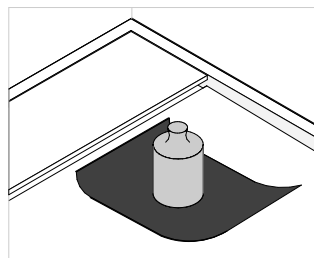
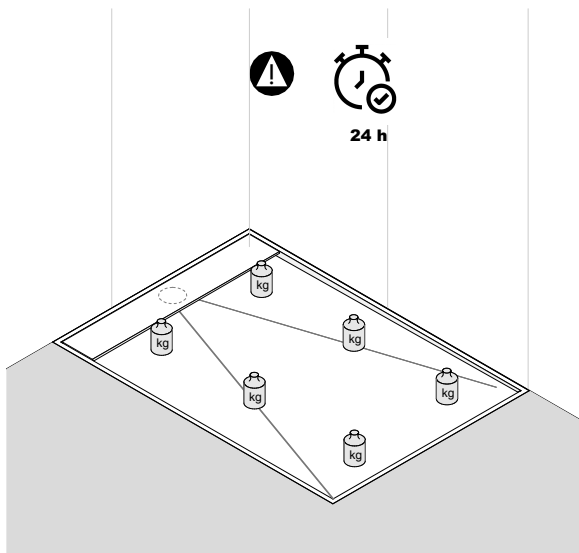

/ 09

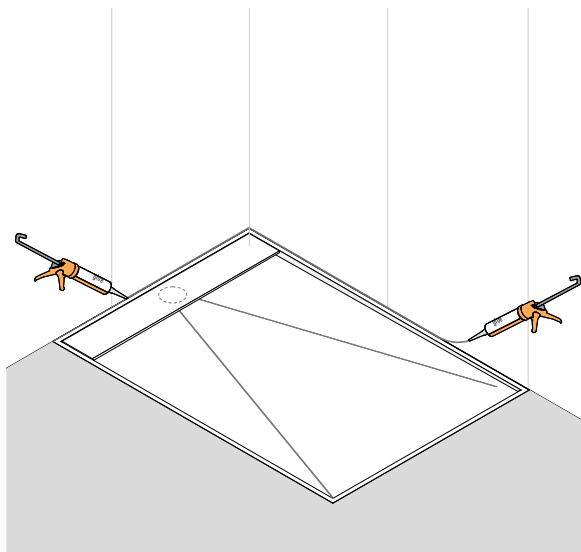

/ 10

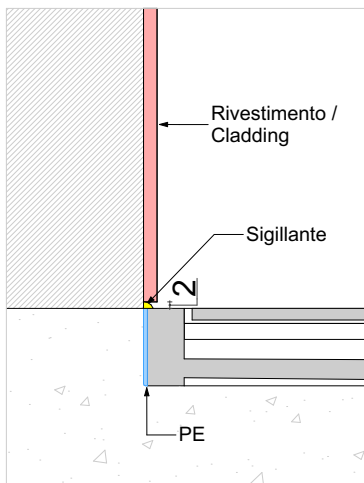

TIPO A

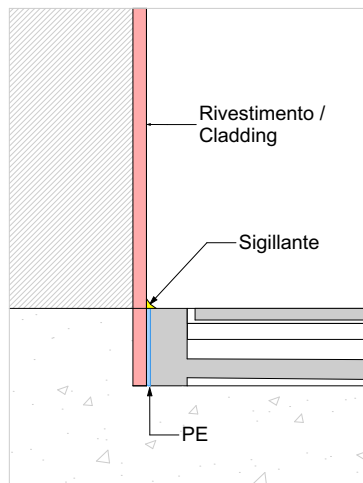

TIPO B

MAKRO
bathroomconcepts

Tel. +39 049 991 09 51